EXHIBIT MS2

No.	Documents	Pages
1.	Index of Video Evidence	1 - 2
2.	Hertfordshire Constabulary Arrest Information	3 – 14
3.	Xanthe Wells Tyre Damage Map	15 - 19
4.	Image of Xanthe Wells	20
5.	MG 11 Witness Statement of PC Jack Marzec	21 – 23
6.	Nikola Muratova Tyre Damage Map	24 – 26
7.	Robert King-Houston Tyre Damage Map	27 – 32
8.	Image of Vojtech Palencar	33
9.	Image of Vojtech Palencar	34
10.	Jan Kratky Tyre Damage Map	35 – 36
11.	MG 11 Witness Statement of PC Gibb	37 – 38
12.	Vaclav Opatril Tyre Damage Map	39 – 42
13.	MG 11 Witness Statement of Sadie Scully	43 – 45
14.	MG 11 Witness Statement of Ireneusz Sokolowski	46 – 47
15.	Order of Foster J dated 26 January 2023	48 – 98
16.	Just Stop Oil Web Page	99 – 104
17.	Cambridge Constabulary Web Page	105
18.	BBC News Page – Sandringham Estate	106 – 111
19.	Animal Rising Web Page	112
20.	Animal Rising Web Page	113

Exhibit MS2/1 – Video Index

Video No.	Source
1.	Arla CCTV
2.	Arla CCTV
3.	Arla CCTV
4.	Arla CCTV
5.	Video captured by one of the lorry drivers contracted from XPO Logistics, Mr Sajmir Xhepmeta
6.	Video captured by Daniella Remenyi an employee of the First Claimant
7.	Video captured by Warren Potter an employee of the First Claimant
8.	Animal Rebellion - uploaded by Animal Rebellion to an online bank on videos and photos
9.	Video captured by Daniella Remenyi an employee of the First Claimant
10.	Arla CCTV
11.	Herefordshire Police – Body worn camera of PC David Vass
12.	Arla CCTV
13.	Arla CCTV
14.	Dashboard camera of an Arla Lorry
15.	Video captured by Phil Gibbons an employee of the First Claimant
16.	Arla CCTV
17.	Animal Rebellion - uploaded by Animal Rebellion to an online bank on videos and photos
18.	Video captured by Daniella Remenyi an employee of the First Claimant
19.	Arla CCTV
20.	Arla CCTV
21.	Arla CCTV
22.	Animal Rebellion - uploaded by Animal Rebellion to an online bank on videos and photos
23.	Animal Rebellion - uploaded by Animal Rebellion to an online bank on videos and photos

24.	Animal Rebellion - uploaded by Animal Rebellion to an online bank on videos and photos
25.	Arla CCTV
26.	Video captured by Bruno Hill an employee of UK Trucks Limited a supplier the First Claimant
27.	Video captured by Daniella Remenyi an employee of the First Claimant
28.	Video captured by Daniella Remenyi an employee of the First Claimant
29.	Dashboard camera of an Arla Lorry
30.	Arla CCTV
31.	Arla CCTV
32.	Arla CCTV
33.	Arla CCTV

Bryan MONGELLI



Arrested by PC 74 MARZEC in Mosquito Way, Hatfield



Nikola MURATOVA



Arrested by PC 74 MARZEC in Mosquito Way, Hatfield



Social media footage

Radim SANDR



Arrested by PC 74 MARZEC in Mosquito Way, Hatfield



JM/04

Robert HOUSTON



Arrested by PC 74 MARZEC in Mosquito Way, Hatfield



JM/01



318239

EXHIBIT DR/15

Vojtech PALENCAR



Arrested by PC 74 MARZEC in Mosquito Way, Hatfield

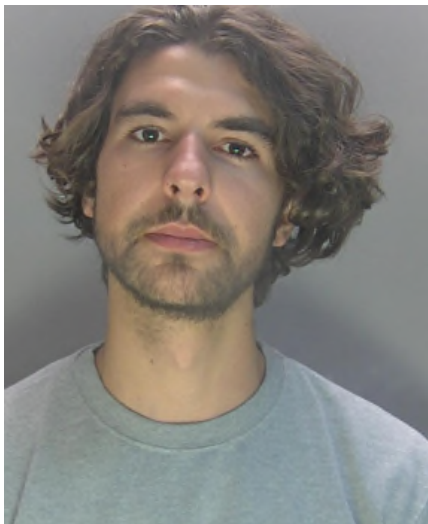

TH/02

Jan KRATKY



Arrested PC 74 MARZEC in Mosquito Way, Hatfield



Anna WILKINSON



Arrested by PC 74 MARZEC in Mosquito Way, Hatfield



CJ/04

[REDACTED]

[REDACTED]

[REDACTED]

[REDACTED]

[REDACTED]

[REDACTED]

[REDACTED]

[REDACTED]

Kim WAINWRIGHT

[REDACTED]

[REDACTED]

[REDACTED]

[REDACTED]

[REDACTED]

[REDACTED]

Arrested by PC 74 MARZEC in Mosquito Way, Hatfield



Lucia ALEXANDER

[REDACTED]
[REDACTED]
[REDACTED]
[REDACTED]
[REDACTED]
[REDACTED]

Arrested by PC 74 MARZEC in Mosquito Way, Hatfield



11/03



318013Goodsam



318239

EXHIBIT DR/15

Rueben LEMER

[REDACTED]

[REDACTED]

[REDACTED]

[REDACTED]

[REDACTED]

[REDACTED]

[REDACTED]

Arrested by PC 74 MARZEC in Mosquito Way, Hatfield



SFH/01

Solene RASHLEIGH



Arrested by PC 74 MARZEC in Mosquito Way, Hatfield



ACB/03



WCP/01C

Xanthe WELLS



Arrested by PC 74 MARZEC in Mosquito Way, Hatfield



Cristina ACOSTA



Arrested by PC GIBB within Arla site, Hatfield



DJG/09

Sined SINGHAGE



Arrested by PC 51 NEATH within Arla Site, Hatfield



Stephen BONE



Arrested by PC GIBB within Arla site, Hatfield



DJG/07

Vaclav OPATRIL



Arrested by PC GIBB within Arla site, Hatfield



DJG/06



Xanthe WELLS

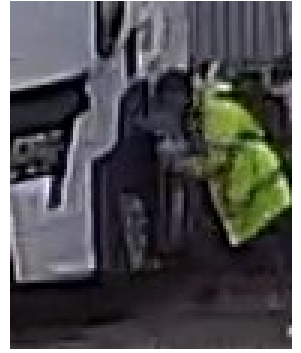
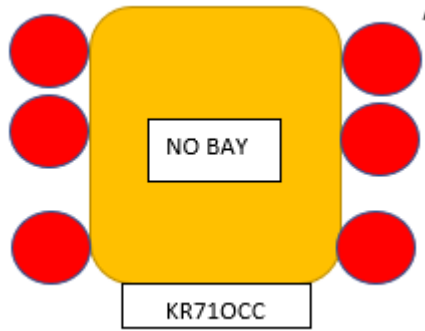

Footage from Yard Tug 1
PG/06

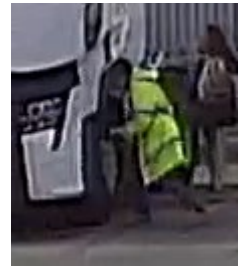

Footage from Yard Tug 1
PG/06

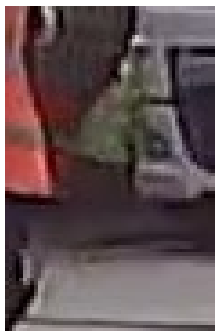

Footage from Yard Tug 1
PG/06

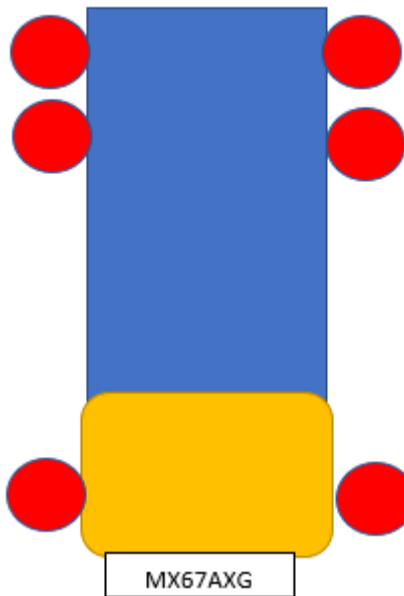

Footage from Yard Tug 1
PG/06

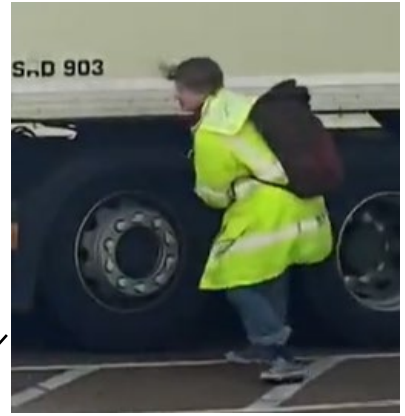
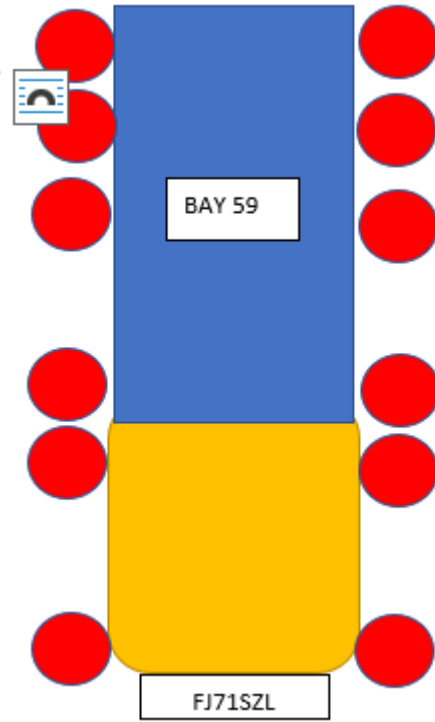

Goodsam 318239
EXHIBIT DR/15



Goodsam 318013
WCP/01D

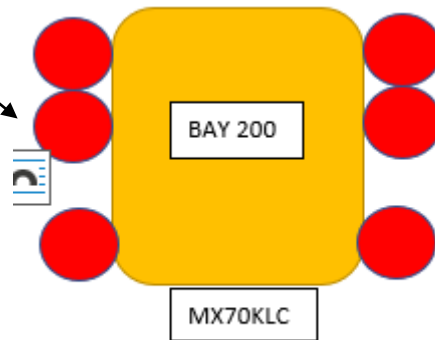

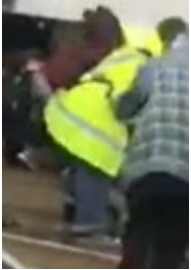

Goodsam 318104
BH/01

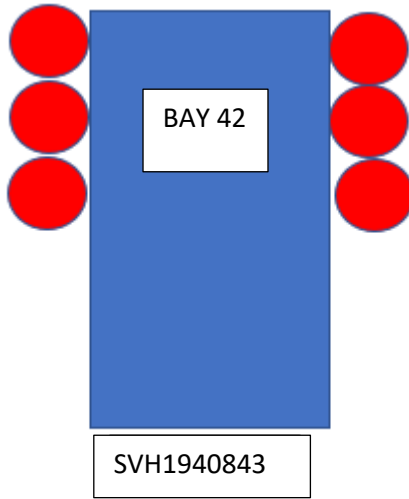

Footage from Yard Tug 1
PG/06

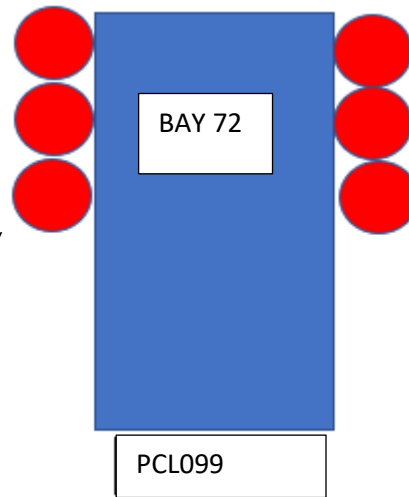

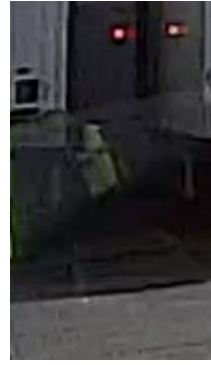
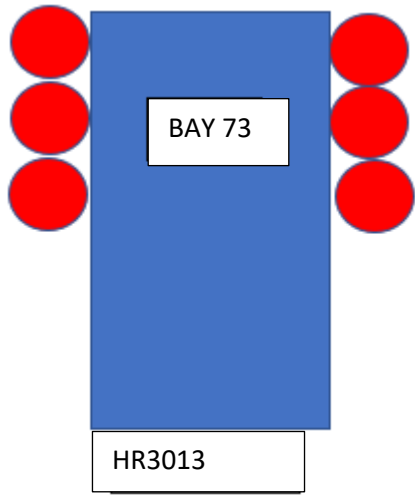

Footage from Yard Tug 1
PG/06

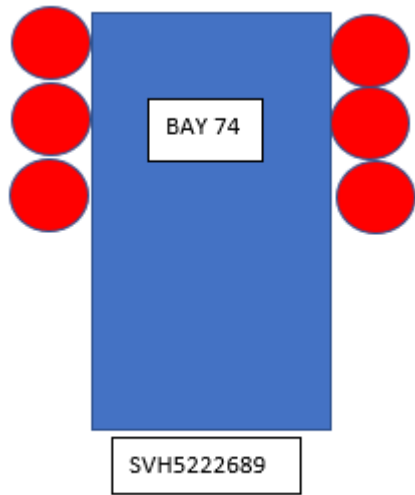

CCTV 101649 PG/04

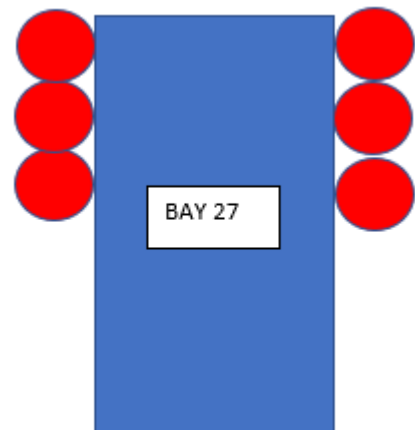

CCTV 102154 PG/04



CCTV 100650
PG/04

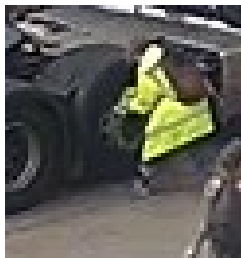
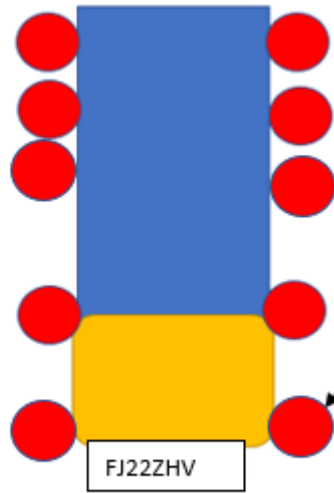
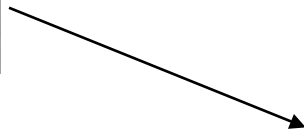

101808
PG04

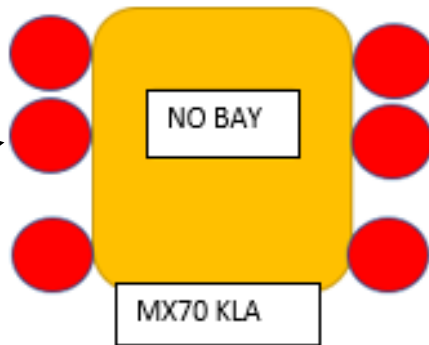



Witness Statement

Criminal Procedure Rules, r 27. 2; Criminal Justice Act 1967, s. 9; Magistrates' Courts Act 1980, s.5B

URN: [] [] [] []

Statement of: PC 74 Jack MARZEC

Age if under 18 (if over insert "over 18"): Over 18 Occupation: Constable

This statement (consisting of3..... pages each signed by me) is true to the best of my knowledge and belief and I make it knowing that, if it is tendered in evidence, I shall be liable to prosecution if I have wilfully stated in it, anything which I know to be false, or do not believe to be true.

I can confirm that the Victim Personal Statement (VPS) has been explained and offered to me. *tick box*
I do/DONOT wish to make a VPS at this time.
I understand that I can make a VPS at any time before a sentencing hearing. *tick box*
**delete as applicable*

Signature: J. MARZEC Date: 08/09/2022

This statement is in relation to 13 arrests I made on THURSDAY 08TH SEPTEMBER 2022 at 10:56AM at MOSQUITO WAY, HATFIELD for Aggravated Trespass and Criminal Damage. I was on duty and in full uniform.
I became aware of an incident at the site and attended. When I first arrived on scene, I activated my personal issue body worn camera (P33021) which I have since uploaded to DEMS. My body worn camera picks up my initial attendance and shows the suspects on top of the lorry and then shows me walking them out of the facility and then me arresting them on the green of MOSQUITO WAY.
I arrived inside the Arla site at Hatfield and became aware of 13 persons within the site that clearly shouldn't be there. I drove on to the site in to a large area where lorries were stationary and alighted from my marked police vehicle. I could see a cab of a lorry that was without a trailer and the tops of heads of a number of people around it and on top of it. Initially, I was the only uniformed officer present that I was aware of albeit I came to know that there was another officer present wearing all black. I observed the persons on the cab of the lorry and reported back to our control room as to what the situation on site was.
As I stood and observed those on the lorry, I could also see further people behind them walking around being watched by PCSOs that had arrived before me and staff from the site that were identifiable from their High vis jackets. They were all within the fenced and gated boundary of Arla and were holding flags and talking to eachother and they had been corralled by staff and PCSOs. Those on the lorries then started to come down to the ground and join the others in to a group. I then watched as the group started to walk towards the gates of Arla and myself and the PCSOs were around them, walking with them whilst I was communicating with our control room and waiting for further officers to arrive.
The group walked out of the site and sat on a bank of grass next to a roundabout outside the site on Mosquito Way. I remained with them, as did the PCSOs.
I then received information that the persons had entered the site and used drills to drill holes in to numerous lorry tyres causing damage. After a few more officers arrived, upon instruction from Inspector SUCH, I read out the time which was 10:56AM and said "YOU ARE ALL UNDER ARREST ON SUSPICION OF CRIMINAL DAMAGE AND AGGRAVATED TRESPASS – YOU DO NOT HAVE TO

Signature: J. MARZEC Signature Witnessed by: PC 74 MARZEC

Witness Statement

Continuation of Statement of PC 74 Jack MARZEC

SAY ANYTHING HOWEVER, IT MAY HARM YOUR DEFENCE IF YOU DO NOT MENTION WHEN QUESTIONED, SOMETHING WHICH YOU MAY LATER RELY ON IN COURT, ANYTHING YOU DO SAY MAY BE GIVEN IN EVIDENCE – THE NECESSITIES OF YOUR ARREST ARE TO ALLOW PROMPT AND EFFECTIVE INVESTIGATION BY MEANS OF INTERVIEW AND TO ALSO PREVENT ANY FURTHER DAMAGE TO PROPERTY.

None of the 13 persons I arrested made any response to caution after being arrested, they just all looked at me and smiled and seemed to understand why they were being arrested. Due to the number of prisoners, other officers at the scene then assisted in the physical detention and search of prisoners and conveying them to available custody suites. I was not aware of the names of the 13 persons I arrested at the point of arrest but I have subsequently reviewed the custody suites and images of detainees and can now as a result identify them by name.

I have reviewed all of the HATFIELD & STEVENAGE prisoners and have confirmed their details.

Myself and PC 157 ORCHARD (NB535) conveyed 3 prisoners to Stevenage custody suite. Robert HOUSTON custody reference 41E1/3525/22 and I took photographs of him which I exhibit as JM/01,2 and 3 along with a further detainee, Bryan MONGELLI custody reference 41E1/3526/22 who I did not have the opportunity to obtain images of. The third prisoner was Radim SANDR custody reference 41E1/3523/22 and I exhibit images of him as JM/04, 5 and 6. I also seized SANDR's mobile phone which I exhibit as JM/07 and have uploaded this to the PMS system under the reference: B2/043710/22.

I have then reviewed all of the custody records and incident log and have established the continuity of which officers conveyed which of the persons I arrested and ultimately the identity of those I arrested.

PC 509 GILES (NB745) – conveyed Nikola MURATOVA custody reference 41E1/3522/22 to STEVENAGE CUSTODY, from reviewing the custody photo, I can confirm that this is the female that was part of the protest group I arrested.

PC 1044 HALL and PC 451 PHILLPOTTS (ND528) conveyed Vojtech PALENCAR custody reference 41E1/3524/22 to STEVENAGE CUSTODY. Images of the suspect were obtained by PC 1044 HALL and from reviewing these images shown to me by PC HALL, I can confirm that this is the male that was part of the protest group I arrested.

I have then reviewed the incident log and from identifying the attending officers and then reviewing the custody records, I can state that the following prisoners were also arrested by myself.

PC 1595 WILLIAMS (NJ724) conveyed Xanthe WELLS custody reference 40AD/2578/22 and Anna WILKINSON custody reference 40AD/2577/22 to KEMPSTON CUSTODY.

PC 1470 KANETSKI (NB737) conveyed Elinor JOSEPH custody reference 40AD/2574/22 to KEMPSTON CUSTODY.

PC 1581 MORTON & PC 1594 GOTTMANN (NT722) conveyed Jan KRATKY custody reference 40AD/2576/22 to KEMPSTON CUSTODY.

PC 848 BERWICK (ND730) conveyed Kim WAINWRIGHT custody reference 40AD/2575/22 to KEMPSTON CUSTODY.

PC 259 BULTITUDE (NJ748) conveyed Solene RASHLEIGH custody reference 40AD/2570/22 to KEMPSTON CUSTODY.

PC 1542 HYLANDS & PC 2890 VASS (NF522) conveyed Rueben LEMER custody reference 40AD/2571/22 to KEMPSTON CUSTODY.

Signature:

Signature Witnessed by:

PC 74 MARZEC

01/2018

Witness Statement

Continuation of Statement of **PC 74 Jack MARZEC**

PC 2119 IQBAL (NF737) conveyed Lucia ALEXANDER custody reference 40AD/2573/22 to KEMPSTON CUSTODY. It is stated on the custody record that the above officer arrested. This is not the case. The suspect was arrested by me, PC IQBAL conveyed to KEMPSTON CUSTODY on my behalf.



Signature:



Signature Witnessed by:

PC 74 MARZEC

01/2018

Nikola MURATOVA

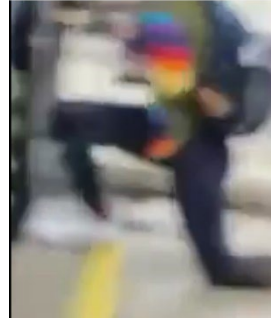

VID-20220912-
WA0008
PG/07

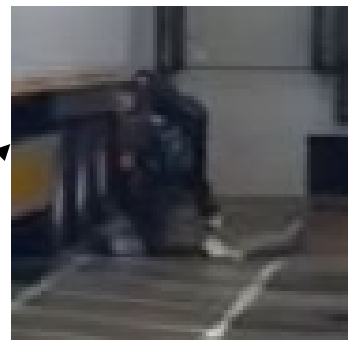
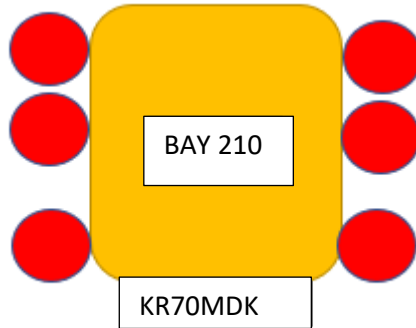

VID-20220912-
WA0009
PG/07

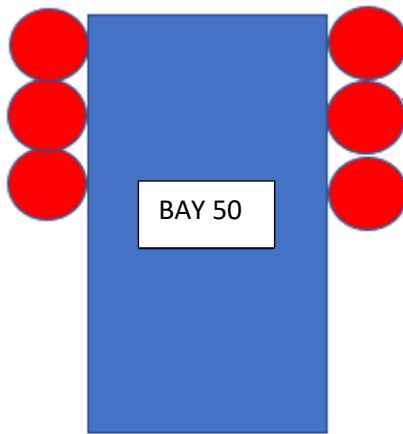

WCP/01C
318035

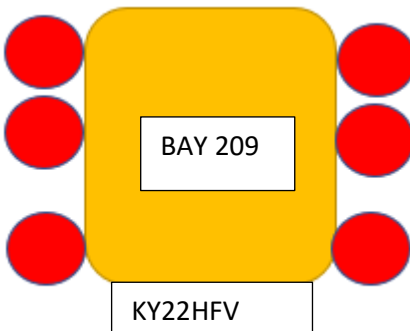
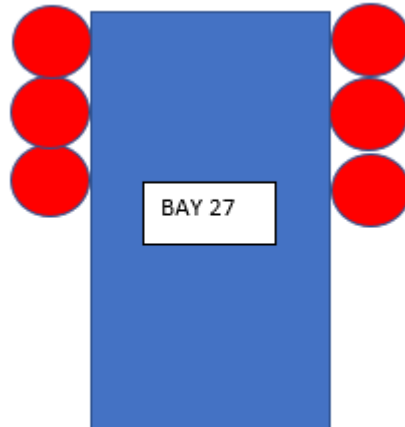
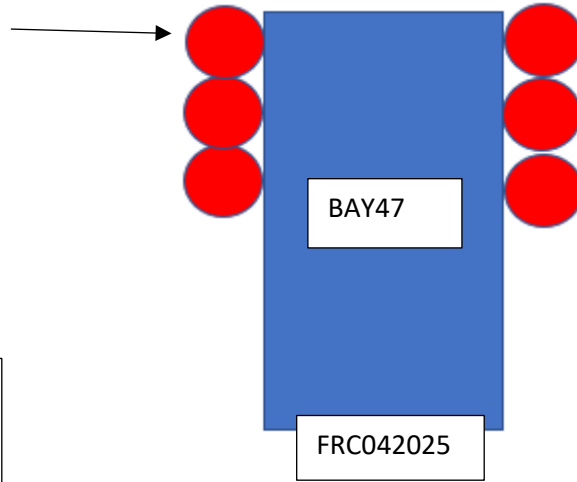



EXHIBIT DR/20

318233



CCTV 102154

PG/04



CCTV 101649

PG/04

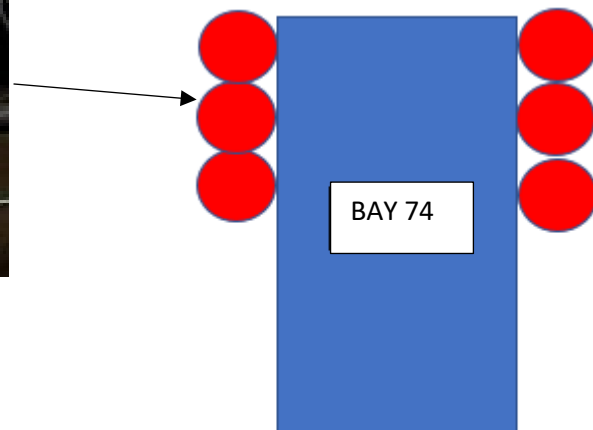



101808
PG04

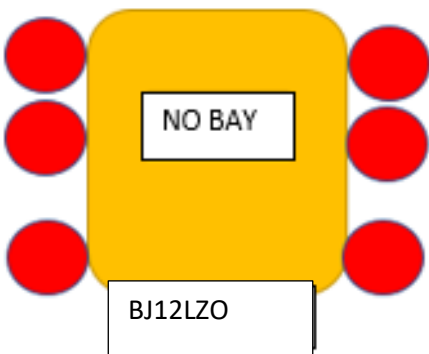

Robert HOUSTON

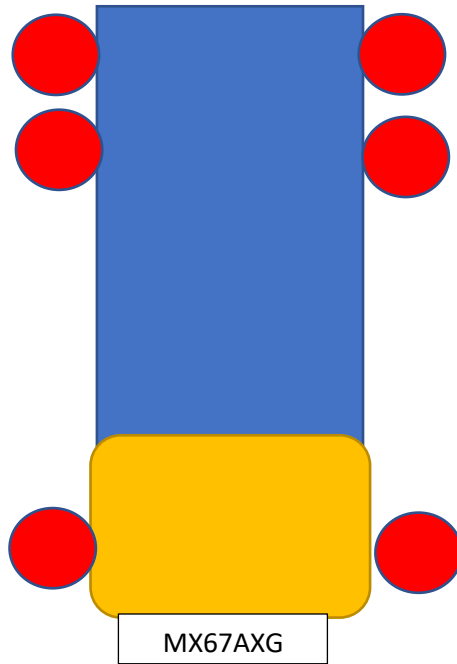

Footage from Yard Tug
1
PG 06



318239
EXHIBIT DR/15

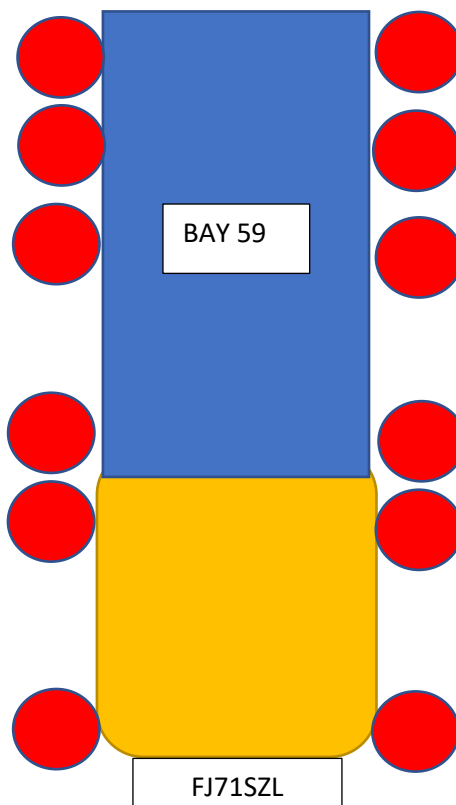

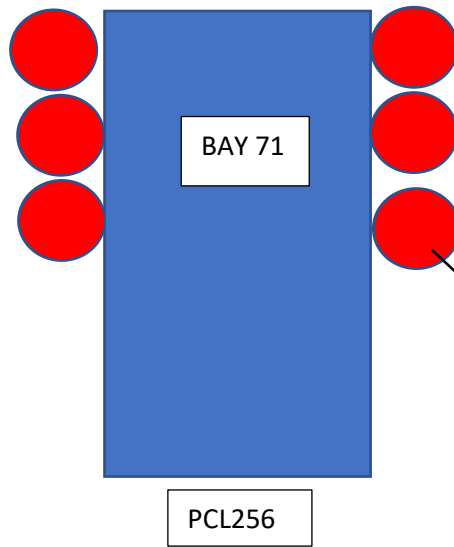

318240
EXHIBIT DR/14

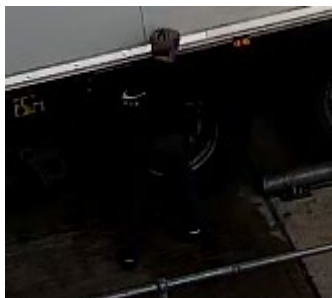
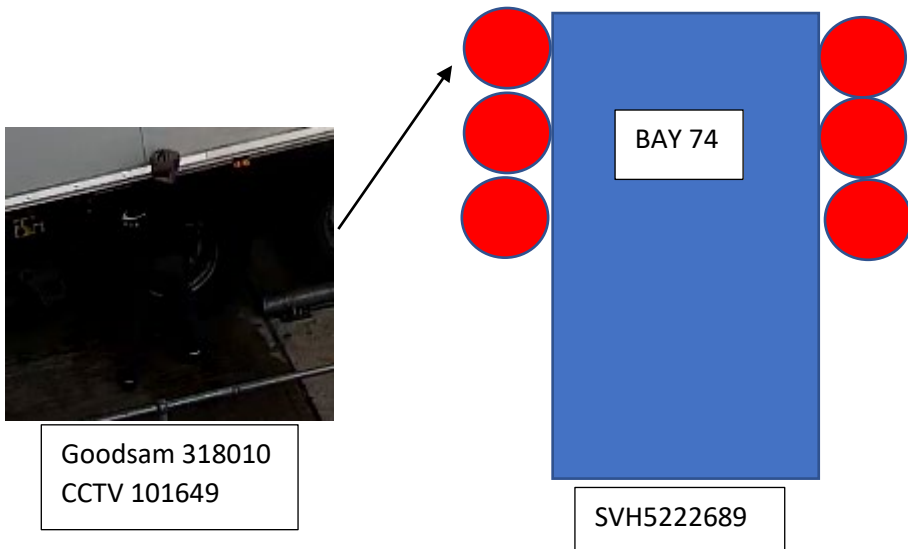
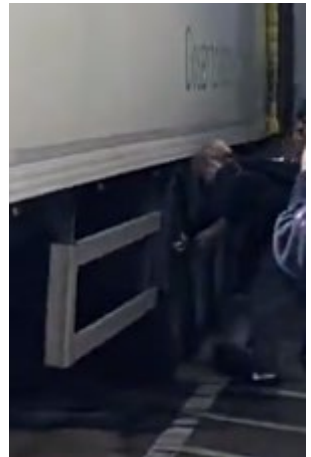

Goodsam 318010
CCTV 101649



Goodsam 38013
WPC/01D

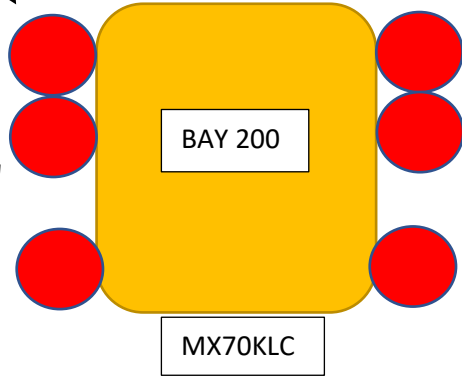

Goodsam 318013
WPC/01D



VID-20220912-WA0008
PG 07

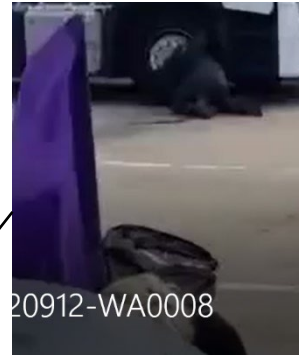

VID-20220912-WA0008
PG 07

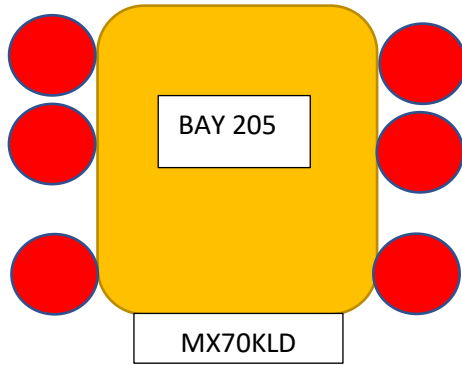

VID-20220912-WA0008
PG 07

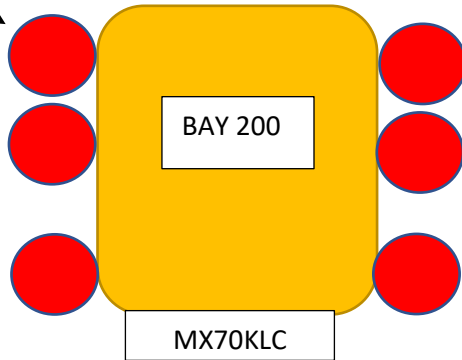

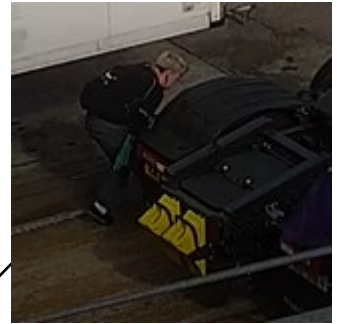
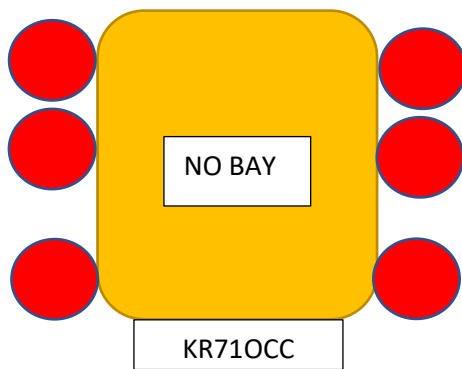

101649
PG 04

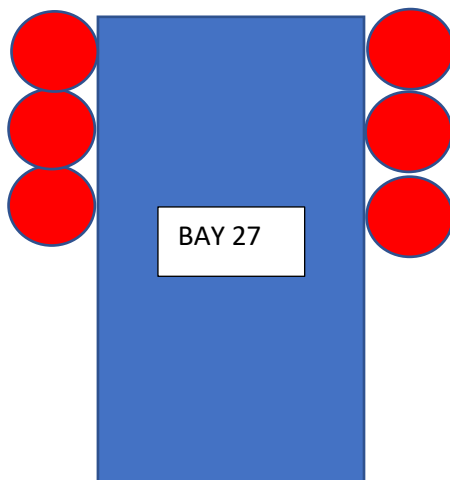

PG04
102154



101820
PG04

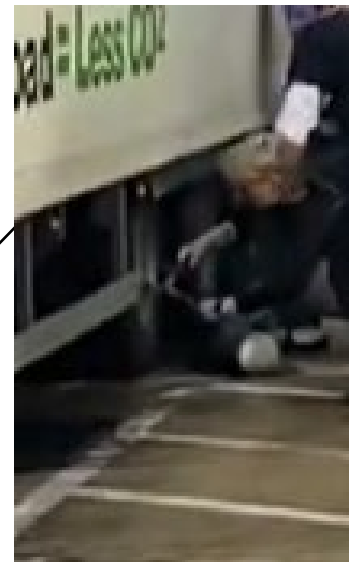
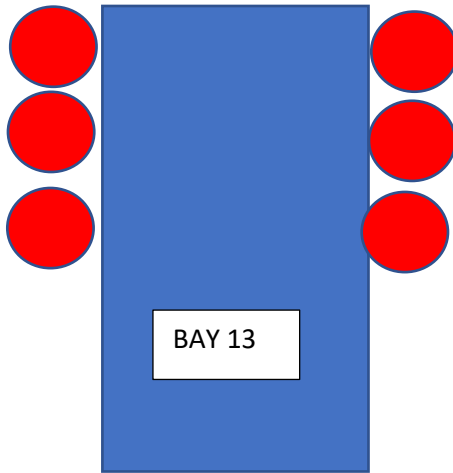

318239
EXHIBIT DR/15

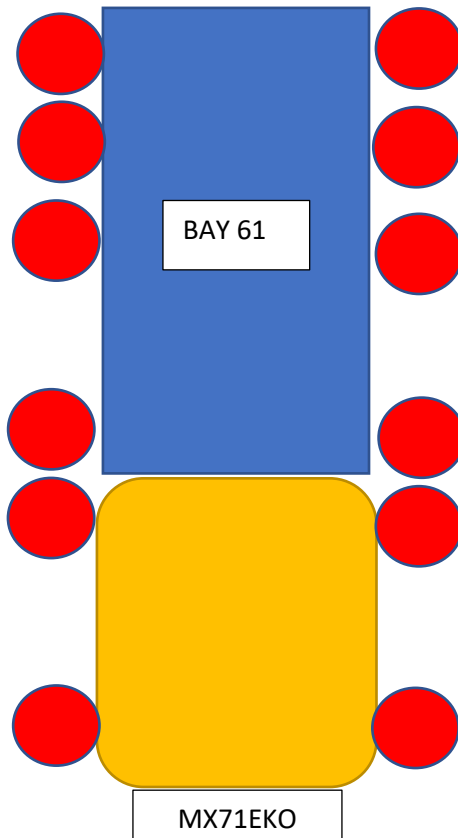

Dash cam KM70CPO
PG 05

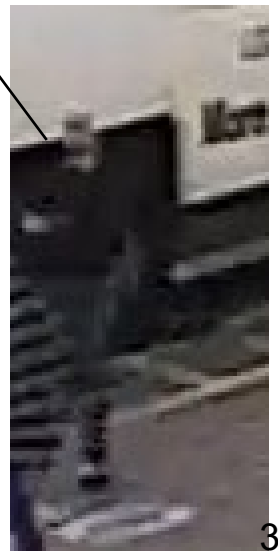





Jan KRATKY

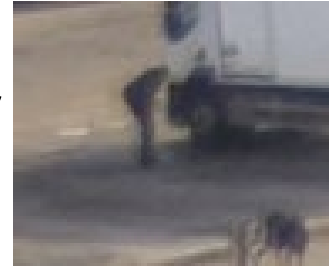
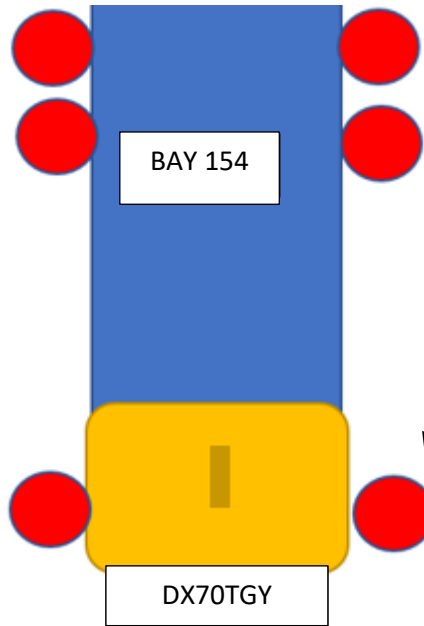

PG/04 CCTV
101512-001

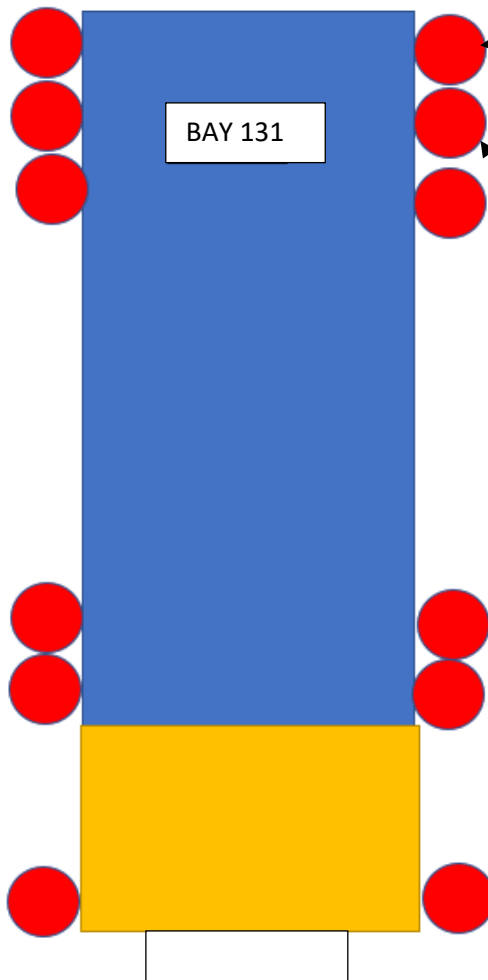

PG/04 CCTV
101342



PG/04 CCTV
101437



PG/04 CCTV
100650

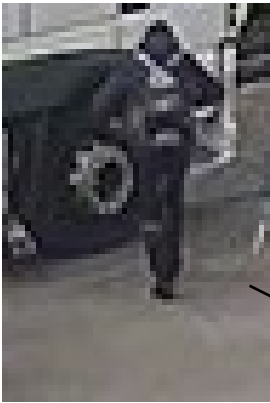
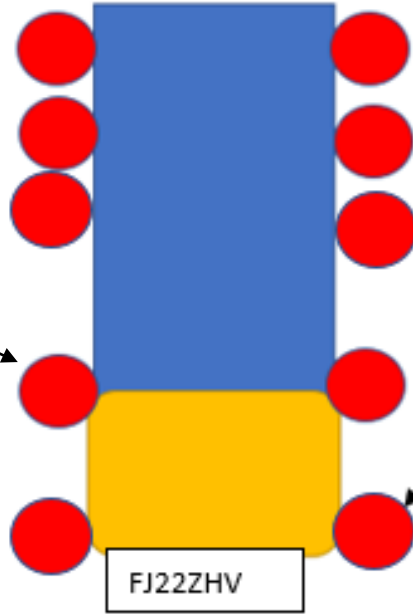

101808
PG04

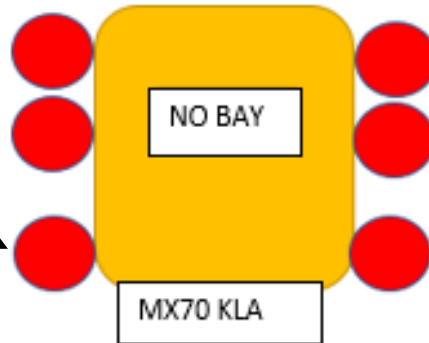

Witness Statement

Criminal Procedure Rules, r 27. 2; Criminal Justice Act 1967, s. 9; Magistrates' Courts Act 1980, s.5B

URN: [] [] [] []

Statement of: David Gibb

Age if under 18 (if over insert "over 18"): Over 18

Occupation: Police Officer

This statement (consisting of2..... Pages(s) each signed by me) is true to the best of my knowledge and belief and I make it knowing that, if it is tendered in evidence, I shall be liable to prosecution if I have wilfully stated in it, anything which I know to be false, or do not believe to be true.

I can confirm that the Victim Personal Statement (VPS) has been explained and offered to me [] tick box

I do /I do not* wish to make a VPS at this time

I understand that I can make a VPS at any time before a sentencing hearing [] tick box

*delete as applicable

Signature: _____

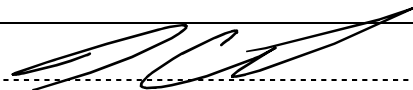

Date: 08/09/2022

This statement is in relation to the arrest of two persons on suspicion of CRIMINAL DAMAGE and three persons AGGREVATED TRESSPASS.

I was on duty under callsign TS45 double crewed with PC 63 JONES when a call was received that there were potential protesters on site at ARLA FOODS, 4000 MOSQUITO WAY, HATFIELD.

While on route to the location I heard on the radio that NB521 had arrested one on suspicion of criminal damage.

I arrived and overheard from staff that the group of protesters had used drills to drill through lorry tyres within their fleet. I was directed to the other side of the building where the group had now run off to.

As I got to the other side of the building, I noted a large group of approximately fifteen people moving around the building away from me. As I pulled up, I noticed two males both holding a drill each in their hands. The male on the right was holding a yellow and black drill in his right hand and the male on the left was holding a dark coloured drill in his right hand. I therefore got out of my vehicle, approached both males and said " STOP, STAND STILL, YOU ARE UNDER ARREST ON SUSPICION OF CRIMINAL DAMAGE" I fully cautioned both males with no reply from either and I placed one of the males I now know to be Vaclav OPATRIL into handcuffs in a rear stack as I noted that my colleague had continued walking towards other members of the protest group and I was now on my own with two arrested. I then said TIME OF ARREST IS 1023HRS. The other male I arrested I now know to be Stephen BONE appeared to be compliant as well as the other female who I now know to be Cristina ACOSTA. All three sat down on the floor. I then explained to BONE that he may not have fully heard me, so I explained to him saying "YOU ARE UNDER ARREST ON SUSPICION OF CRIMINAL DAMAGE" and I fully cautioned him again. I also explained "THE NECESSITY FOR ARREST IS FOR A PROMPT AND EFFECTIVE

Signature: _____



Signature Witnessed by: _____

Witness Statement

Continuation of Statement of David Gibb

INVESTIGATION BY MEANS OF AN INTERVIEW AND TO PREVENT ANY FURTHER DAMAGE TO PROPERTY". I did not place BONE in handcuffs as my colleague PC JONES returned to me.

During this time, I could hear that the remainder of the group had left the inside of the site within Arla and had made their way back around to the pedestrian entrance and were now outside. I waited for a further unit to arrive to assist in conveying. I also placed both seized drills into separate evidence bags and placed them into the boot of my marked police vehicle.

I then searched both arrested males under section 32 of PACE prior to placing them into the rear of my marked police vehicle where I found nothing further of any significance.

I then received direction from Oscar One that anyone within the grounds of Arla should be arrested on suspicion of aggravated trespass. I therefore explained to ACOSTA, "TIME IS 1047HRS, I AM ARRESTING YOU ON SUSPICION OF AGGRAVATED TRESSPASS, Fully Cautioned with no significant response and then said, "NECESSITY FOR ARREST IS FOR A PROMPT AND EFFECTIVE INVESTIGATION BY MEANS OF INTERVIEW AND TO PREVENT AND FURTHER DAMAGE TO PROPERTY".

I then spoke to both arrested males and further arrested OPATRIL at 1055hrs and BONE at 1056hrs on suspicion of AGGRAVATED TRESSPASS. I explained to both males that the same caution still applies.

I then conveyed both OPATRIL and ACOSTA in my vehicle along with PC JONES and PC 281 along with PC 2573 conveyed BONE to Hatfield custody where all three detention was further authorised by the custody sergeant. During this time, I took head to toe pictures of the suspects which I will exhibit as:

- DJG/06- Image of OPATRIL
- DJG/07 – Image of BONE
- DJG/09 – Image of ACOSTA

I have then returned to the report writing room where I have completed the relevant paperwork and booked in seized property and took pictures of both seized items which I will exhibit as follows:

- DJG/01 – Yellow/Black Drill
- DJG/02 – Blue/Black Drill
- DJG/03 – Picture of Yellow/Black Drill
- DJG/04 – Picture of Blue/Black Drill

I also downloaded my body worn camera (P59693) footage to the secure DEMS storage system which I will exhibit as DJG/08.



Signature:



Signature Witnessed by:

.....

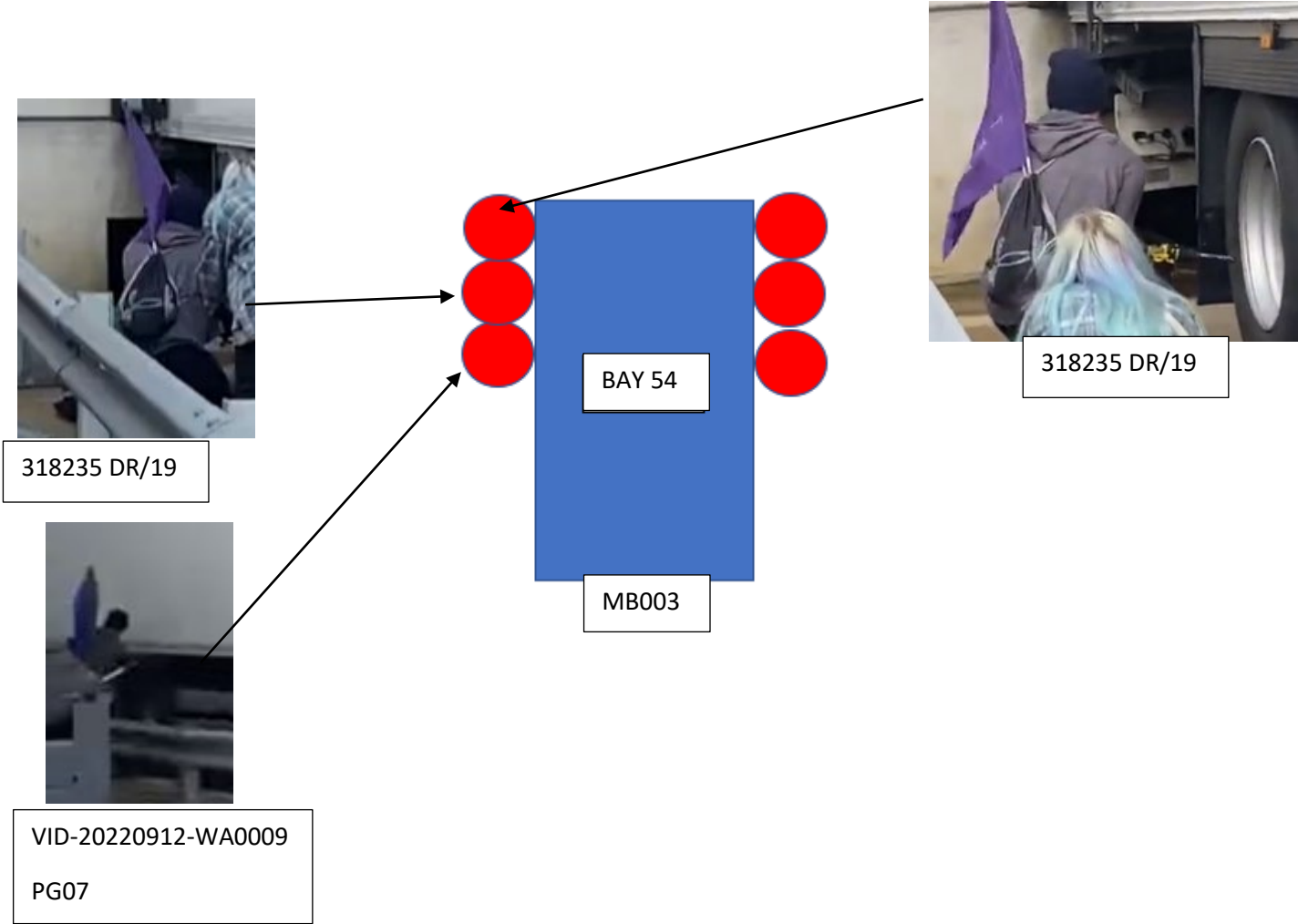

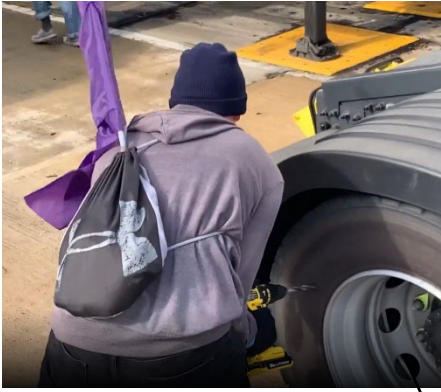

318235
PG04



318235
PG04

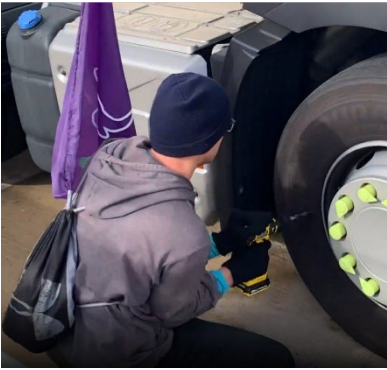

318235
PG04

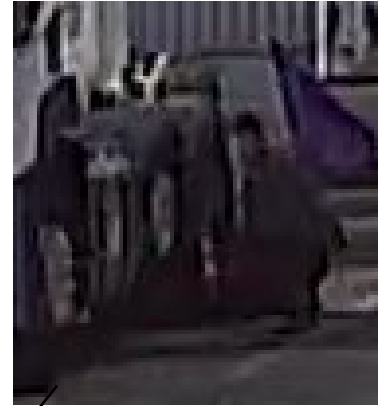

Footage from Yard
Tug 1
PG06

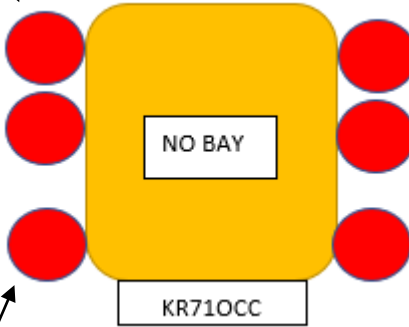

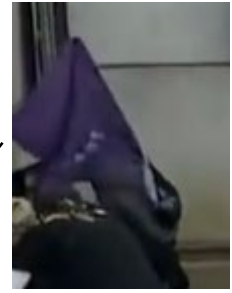

Goodsam
318239 EXHIBIT
DR/15

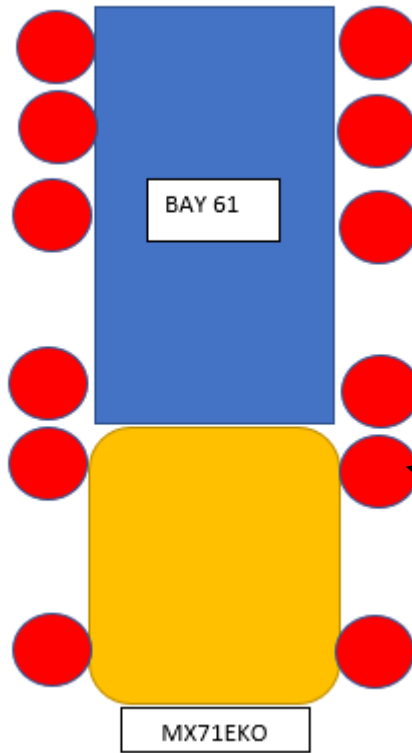

Goodsam
318239 EXHIBIT
DR/15

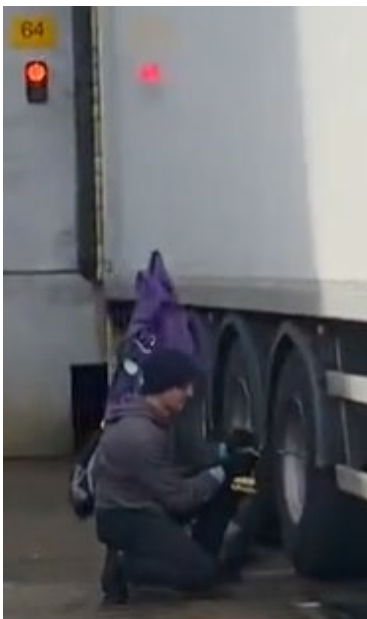

318240
EXHIBIT DR/14

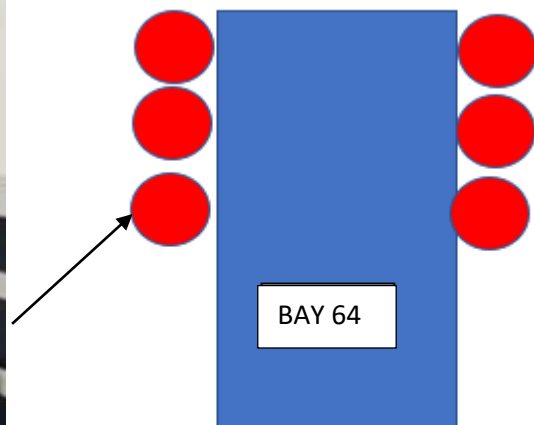

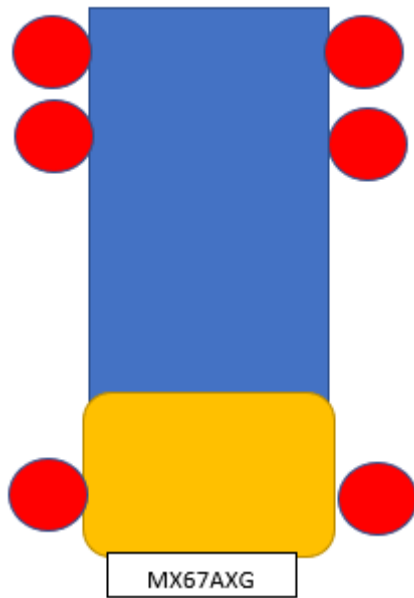

PG04
101342

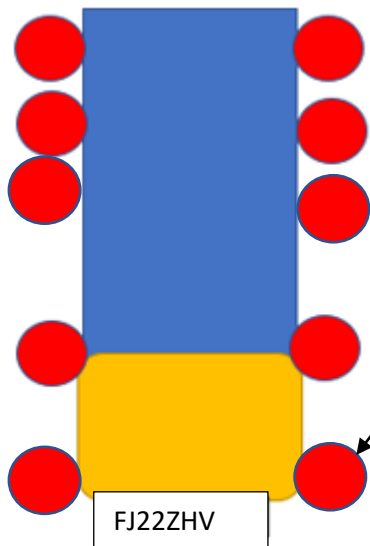

PG04
100650

Witness Statement

Criminal Procedure Rules, r 27. 2; Criminal Justice Act 1967, s. 9; Magistrates' Courts Act 1980, s.5B

URN: [] [] [] []

Statement of: Sadie SCULLY

Age if under 18 (if over insert "over 18"): Over 18 Occupation: Stock controller

This statement (consisting of pages(s) each signed by me) is true to the best of my knowledge and belief and I make it knowing that, if it is tendered in evidence, I shall be liable to prosecution if I have wilfully stated in it, anything which I know to be false, or do not believe to be true.

I can confirm that the Victim Personal Statement (VPS) has been explained and offered to me. tick box

I do not wish to make a VPS at this time.

I understand that I can make a VPS at any time before a sentencing hearing. tick box

*delete as applicable

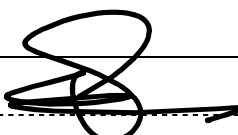
Signature:  Date: 08/09/2022

This statement is in relation to a protest which happened at ARLA, Hatfield on the 8th September 2022.

ARLA is a dairy logistics company where I work. I have worked at ARLA for 12 years and I work in the stock team. My role as stock controller involves managing a team of people and keeping my eye on problems involving stock or distribution issues. I work in the dispatch office which is opposite the security office and is located at the back of the building where all the lorries are parked. The lorries are either waiting for stock to be loaded onto them or have bought stock in. I believe most of the lorries damaged today by the protesters were having stock loaded onto them.

At around 10am I was in the dispatch office talking to the vet who was on site. The vet who I know to be called OLIVIA went to check a trailer number for a lorry which was going to Ireland. OLIVIA then came back and said that she thought she could see protesters on site. I have then left the office, stood on the steps which face the security office, I could see my managers MARK and DANIELLA and some other staff members in hi-vis vests. I have then seen what I believe to be protesters going in between the parked lorries. The protesters have had drills and flags in their hands. I could tell they were protesters due to the banners they were waving. I believe one of the banners said something about 'PLANT BASED'. I think I saw two or three people with drills in their hands and believe I saw fifteen people protesting overall. The three protesters who were holding drills were holding them in their hands. One protesters had the drill in their hand and was holding it down towards the ground however, one of the protesters was holding the drill up like a gun. I think one protester who was holding the drill was male

Signature:  Signature Witnessed by: _____

Witness Statement

Continuation of Statement of

and the other one was female and I cannot remember the sex of the other protester. I remember seeing one of the drivers try to stop the protesters and they pushed past him like they did not care.

The next thing I remember is feeling panicky. I suffer from panic attacks due to anxiety and over the last few months it has got worse, I am currently waiting to see a specialist about this. I remember feeling scared and uneasy about seeing the protesters. I started to shake and I felt really worried. I was worried about what the protesters might do. The protesters didn't really look at me or look like they wanted to get into the building however, it was the uncertainty of what they would do which is what made me feel scared and anxious. In the twelve years I have worked at ARLA I have never experienced any protests so this experience was new to me. I remember sitting down on the bottom step because I was worried I was going to pass out and hurt myself. Two of my colleagues KELLY and CHRISTINA, who are first aid trained, were standing near me and came to my aid. I felt myself going to pass out but KELLY held me so I didn't. I remember my chest starting to feel really really tight and I felt like I couldn't breath properly. Both KELLY and CHRISTINA were talking to me saying things like 'BREATH BREATH'. I then went back into the office and sat down. At this point I remember feeling really dizzy and I could see black spots flashing before my eyes. I usually experience the flashing when I am having a panic attack. I believe this whole incident lasted about 5 minutes. I am also suffering from acid reflux which is bought on by stress.

Two hours after the incident I am still feeling shaky and anxious. Due to the security situation, I am unable to leave the building and walk around which is how I usually cope with my anxiety. This is making me feel much worse. I haven't been able to eat properly since the incident as I feel sick. I have tried to work as normally as I can however, I cannot concentrate due to the anxiety I feel. It is taking me much longer to concentrate on tasks due to how I feel. I do not know if I will be able to come back to work tomorrow. It will depend on how anxious I feel when I wake up. I feel angry that the protesters have wasted time and money. There will be drivers for example, who will now have to work later and this makes me feel angry and upset that they will not see their families.



Signature:

Signature Witnessed by:

Witness Statement

Continuation of Statement of

.....

.....

Signature: **Signature Witnessed by:**

Witness Statement

Criminal Procedure Rules, r 27. 2; Criminal Justice Act 1967, s. 9; Magistrates' Courts Act 1980, s.5B

URN: [] [] [] []

Statement of: Ireneusz SOKOLOWSKI

Age if under 18 (if over insert "over 18"): OVER 18

Occupation: CHUNTER

This statement (consisting of2..... Pages(s) each signed by me) is true to the best of my knowledge and belief and I make it knowing that, if it is tendered in evidence, I shall be liable to prosecution if I have wilfully stated in it, anything which I know to be false, or do not believe to be true.

I can confirm that the Victim Personal Statement (VPS) has been explained and offered to me [] tick box

I do /I do not* wish to make a VPS at this time

I understand that I can make a VPS at any time before a sentencing hearing [] tick box

*delete as applicable

Signature:

[Handwritten Signature]

Date: 08/09/2022

This is a statement in relation to an incident that occurred on THURSDAY 8th of SEPTEMBER 2022 at approximately 1030hrs on the Arla delivery yard on GYPSY MOTH AVENUE, HATFIELD, HERTFORDSHIRE, AL10 9US.

On THURSDAY 8th of SEPTEMBER 2022 at approximately 0700hrs I was on duty and I was coordinating the lorry trailers into the warehouse bays.

At approximately 1000hrs I went to the town to buy some food and shortly after I received a call by another colleague who informed me that there is a group of people at the back yard and they are causing damage to the lorry tyres.

As soon I was informed of what was happening I rushed back to the warehouse so I can help with the situation. Whilst on the way back a lot of things were going through my mind. Before I arrived at the location I felt scared as I did not want to get hurt and I didn't want anything to happen to me as I got a partner to look after and a baby on the way.

As soon as I got to the back yard I could see police cars and I could see police officers had already arrested some people.

I was not involved at all in the incident but the whole situation has affected me as I have not had a break after eleven hours of work due to the incident.

Signature:

[Handwritten Signature]

Signature Witnessed by:

[Handwritten Signature]

Witness Statement

Continuation of Statement of _____

This incident has caused me stress as I do not feel safe coming to work in case another group of protesters turn up again and do something worst.

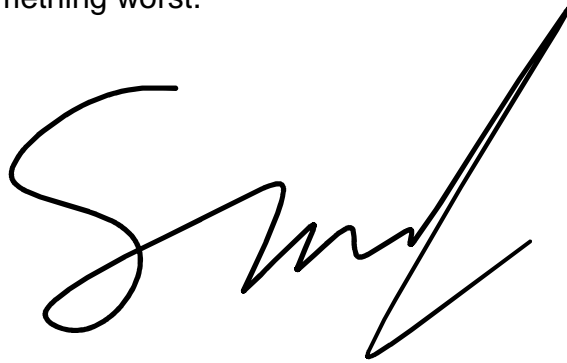

Signature:

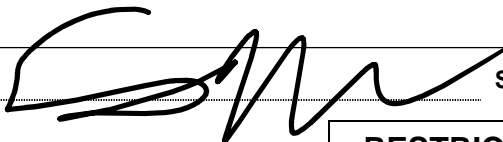

Signature Witnessed by:

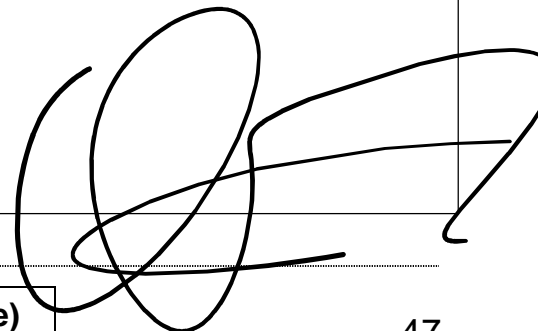

In the matter of an application for an injunction made pursuant to the Local Government Act 1972, s222 and the Highways Act 1980, s130(5)

26th January 2023
Before Mrs Justice Foster DBE

B E T W E E N :

- (1) THURROCK COUNCIL
(2) ESSEX COUNTY COUNCIL



QB-2022-001317
Claimants

-and-

- (1) MADELINE ADAMS
- (2)-(222) OTHER NAMED DEFENDANTS AS LISTED AT SCHEDULE 1 TO THE CLAIM FORM
- (223) PERSONS UNKNOWN, WHO ARE FOR THE PURPOSE OF PROTESTING, CAUSING THE BLOCKING, ENDANGERING, SLOWING DOWN, OBSTRUCTING, PREVENTING OR OTHERWISE INTERFERING WITH THE FREE FLOW OF TRAFFIC ON TO, OFF OR ALONG THE ROADS LISTED AT ANNEXE 1 TO THE CLAIM FORM
- (224) PERSONS UNKNOWN, WHO ARE FOR THE PURPOSE OF PROTESTING, AND WITHOUT THE PERMISSION OF THE REGISTERED KEEPER OF THE VEHICLE, ENTERING, CLIMBING ON, CLIMBING INTO, CLIMBING UNDER, OR IN ANY WAY AFFIXING THEMSELVES OR AFFIXING ANY ITEM TO ANY VEHICLE TRAVELLING ON TO, OFF, ALONG OR WHICH IS ACCESSING OR EXITING THE ROADS LISTED AT ANNEXE 1 TO THE CLAIM FORM
- (225) PERSONS UNKNOWN, WHO ARE FOR THE PURPOSE OF PROTESTING, CAUSING THE BLOCKING, ENDANGERING, SLOWING DOWN, OBSTRUCTING, PREVENTING OR OTHERWISE INTERFERING WITH VEHICULAR ACCESS TO, INTO OR OFF ANY PETROL STATION OR ITS FORECOURT WITHIN THE ADMINISTRATIVE AREA OF THURROCK (AS MARKED ON THE MAP AT ANNEXE 2 TO THE CLAIM FORM)
- (226) PERSONS UNKNOWN, WHO ARE FOR THE PURPOSE OF PROTESTING, CAUSING THE BLOCKING, ENDANGERING, SLOWING DOWN, OBSTRUCTING, PREVENTING OR OTHERWISE INTERFERING WITH

VEHICULAR ACCESS TO OR FROM ANY PETROL STATION OR ITS FORECOURT WITHIN THE ADMINISTRATIVE AREA OF ESSEX (AS MARKED ON THE MAP AT ANNEXE 3 TO THE CLAIM FORM)

(227) PERSONS UNKNOWN, WHO ARE FOR THE PURPOSE OF PROTESTING, BLOCKING, PREVENTING OR OTHERWISE INTERFERING WITH THE OFFLOADING BY DELIVERY TANKERS OF FUEL SUPPLIES AND/OR THE REFUELLING OF VEHICLES AT ANY PETROL STATION WITHIN THE ADMINISTRATIVE AREA OF THURROCK (AS MARKED ON THE MAP AT ANNEXE 2 TO THE CLAIM FORM)

(228) PERSONS UNKNOWN, WHO ARE FOR THE PURPOSE OF PROTESTING, BLOCKING, PREVENTING OR OTHERWISE INTERFERING WITH THE OFFLOADING BY DELIVERY TANKERS OF FUEL SUPPLIES AND/OR THE REFUELLING OF VEHICLES AT ANY PETROL STATION WITHIN THE ADMINISTRATIVE AREA OF ESSEX (AS MARKED ON THE MAP AT ANNEXE 3 TO THE CLAIM FORM)

(229) PERSONS UNKNOWN WHO ARE TRESPASSING ON, UNDER OR ADJACENT TO THE ROADS LISTED AT ANNEXE 1 TO THE CLAIM FORM BY UNDERTAKING EXCAVATIONS, DIGGING, DRILLING AND/OR TUNNELLING WITHOUT THE PERMISSION OF THE RELEVANT HIGHWAY AUTHORITY

Defendants

ORDER

PENAL NOTICE

IF YOU, THE ABOVE NAMED DEFENDANTS OR PERSONS UNKNOWN OR ANY OF YOU DISOBEY THIS ORDER OR INSTRUCT OR ENCOURAGE OTHERS TO BREACH THIS ORDER YOU MAY BE HELD TO BE IN CONTEMPT OF COURT AND MAY BE IMPRISONED, FINED OR HAVE YOUR ASSETS SEIZED.

ANY OTHER PERSON WHO KNOWS OF THIS ORDER AND DOES ANYTHING WHICH HELPS OR PERMITS THE DEFENDANTS TO BREACH THE TERMS OF THIS ORDER MAY ALSO BE HELD IN CONTEMPT OF COURT AND MAY BE IMPRISONED, FINED OR HAVE THEIR ASSETS SEIZED

POWER OF ARREST

THIS ORDER CONTAINS A POWER OF ARREST ATTACHED AT SCHEDULE 3 OF THIS ORDER FOR BREACH OF PARAGRAPHS 2.1 TO 2.16 OF THIS ORDER PURSUANT TO SECTION 27 OF THE POLICE AND JUSTICE ACT 2006. ANY

**PERSON CAUGHT BREACHING PARAGRAPHS 2.1 TO 2.16 OF THIS ORDER
MAY BE ARRESTED AND BROUGHT BEFORE THE COURT**

UPON the Claimants' Application dated 26 January 2023 seeking (i) the adjournment of the final hearing of the Claimants' Claim for final injunctive relief against the Defendants, pending the outcome of the expedited appeal to the Supreme Court in *Wolverhampton City Council & Ors v London Gypsies and Travellers & Ors* (UKSC 2022/0046), which appeal may dispose of part of these proceedings, (ii) the continuation of the Injunction Order dated 27 May 2022 granted by HHJ Simon (sitting as a Judge of the High Court) (the 'Injunction Order'), pending the outcome of the aforementioned appeal and the final hearing of the Claimants' Claim and (iii) a 12 month extension to the power of arrest contained within the Injunction Order

AND UPON the Application being made on notice to those Defendants who have acknowledged service of the Claim and provided an address for service, as per paragraph 11 of the Injunction Order, and with the Application having also been served on the solicitors for the Sixty-Third Defendant and by way of email on the Forty-Eighth, Fifty-First, Eighty-Sixth, One-Hundred and Second and the One-Hundred and Fiftieth Defendants

AND UPON the Court considering the terms of the Injunction Order and the recitals thereto

AND UPON the Court considering the Fourth witness statement of Adam Rulewski dated 25 January 2023

AND UPON the Court considering the Application on the papers and without a hearing

IT IS ORDERED THAT:

Definitions

1. For the purpose of this Order:

- 1.1 "The Roads" shall mean the Roads identified in Annexe 1 to this Order and to the Claim Form as marked in red on the maps at Annexes 2 and 3 to this Order and to the Claim Form.
- 1.2 "The Administrative Area of Thurrock" shall mean the administrative area as marked with the purple line on the map at Annexe 2 to this Order and to the Claim Form.
- 1.3 "The Administrative Area of Essex" shall mean the administrative area as marked with the pink line on the map at Annexe 3 to this Order and to the Claim Form.
- 1.4 "The Administrative areas of Thurrock and Essex" shall mean those areas in 1.2 and 1.3 above.
- 1.5 "The Fuel Terminals" shall refer to the following four sites collectively:

- 1.5.1 The Navigator Fuel Terminal, Oliver Road, West Thurrock RM20 3ED;
- 1.5.2 The Esso Fuel Terminal, London Road, Purfleet RM19 1RS;
- 1.5.3 Exolum Storage Ltd, off Askews Farm Lane, London Road, Grays RM17 5YZ; and
- 1.5.4 Oikos Storage Limited, Haven Road, Hole Haven Wharf, Canvey Island, Essex SS8 0NR.

INJUNCTION

Prohibitions

- 2. Until and subject to any further order of the Court, the Defendants and each of them (whether by themselves or by instructing, encouraging or allowing any other person) are forbidden from:
 - 2.1 Blocking, slowing down, endangering, obstructing or otherwise interfering with the flow of traffic onto or along or off **the Roads** for the purpose of protesting.
 - 2.2 Blocking, slowing down, endangering, obstructing or otherwise interfering with **access to or from the Roads**, and on any adjacent roads, slip roads or roundabouts which are not vested in the Claimants, for the purpose of protesting.
 - 2.3 Entering, climbing onto, climbing into, climbing under **any vehicle** travelling on to, off or along **the Roads** or accessing or exiting the Roads: (a) without the permission of the registered keeper of the vehicle; and (b) for the purpose of protesting.
 - 2.4 Entering, climbing onto, climbing into, climbing under **any vehicle** on any **adjacent roads, slip roads or roundabouts to the Roads**, whether or not those roads are vested in the Claimants: (a) without the permission of the registered keeper of the vehicle; and (b) for the purpose of protesting.
 - 2.5 **Affixing themselves** (“locking on”) to any vehicle travelling on to, off or along the Roads or accessing or exiting the Roads.
 - 2.6 Affixing themselves (“locking on”) to any vehicle on any adjacent roads, slip roads or roundabouts to the Roads, whether or not those roads are vested in the Claimants, where the “locking on” is for the purpose of protesting.
 - 2.7 Affixing themselves (“locking on”) or any other items to any of the Roads or any other person or object on, under or over the Roads.
 - 2.8 Affixing themselves (“locking on”) or any other items to any adjacent roads, slip roads or roundabouts to the Roads, whether or not those roads are vested in the Claimants where the “locking on” is for the purpose of protesting.

- 2.9 **Erecting any structure** on the Roads.
- 2.10 **Tunnelling**, excavating, drilling or digging under or adjacent to the Roads.
- 2.11 **Occupying** existing tunnels under the Roads for the purpose of protesting.
- 2.12 **Causing damage** to the surface of or to any apparatus on or adjacent to the Roads or any vehicle on the Roads for the purpose of protesting.
- 2.13 **Abandoning any vehicle** or item on any Roads, adjacent roads, slip roads or roundabouts to the Roads, whether or not those roads are vested in the Claimants for the purpose of protesting.
- 2.14 Blocking, slowing down, obstructing or otherwise interfering with vehicular access to **any petrol station** in the administrative areas of Thurrock and Essex for the purpose of protesting.
- 2.15 Blocking, endangering, slowing down, obstructing or otherwise interfering with vehicular access to any **petrol station forecourt or access road**, in the administrative areas of Thurrock and Essex for the purpose of protesting.
- 2.16 Blocking, endangering, slowing down, obstructing or otherwise interfering with the offloading by **delivery tankers of fuel supplies** and/or the refuelling of vehicles at any petrol station within the administrative areas of Thurrock and Essex.
- 2.17 **Causing, assisting** or encouraging any other person to do any act prohibited by paragraphs 2.1 to 2.16 above.
- 2.18 **Continuing any acts** prohibited by paragraphs 2.1 to 2.16 above.

Power of arrest

- 3. Pursuant to s.27 Police and Justice Act 2006, a power of arrest shall apply to paragraphs 2.1 to 2.16 above in the form attached at schedule 3 of this Order.

Alternative service

- 4. Pursuant to CPR rules 6.15 and 6.27, the Claimants shall have permission, in addition to personal service, or in the alternative to personal service, to serve the **1st to 222nd Defendants** and any further named Defendants with the Claim Form, Application for an Interim Injunction, the supporting documents relied on in this Claim, and this Order and the power of arrest by **all** of the following methods (4.1 – 4.5 to be treated conjunctively):

- 4.1 **Websites:** placing a copy of the Claim Form, Application for an Interim Injunction, the supporting documents relied on in this Claim, and this Order and the power of arrest on the Claimants' websites and Facebook pages; and

- 4.2 **Email:** sending a copy of this Order to Just Stop Oil, Youth Climate Swarm, Extinction Rebellion and Insulate Britain at the following email addresses: juststopoilpress@protonmail.com; youthclimateswarm@protonmail.com; press@extinctionrebellion.uk; insulatebritainpress@protonmail.com and providing a web link at which they can access the Claim Form, Application for an Interim Injunction, the supporting documents relied on in this Claim, and this Order; and
- 4.3 **Post:** where an address of a named Defendant is known to the Claimants, by posting a copy of this Order together with a covering letter through the letterbox of the named Defendant's address (or by leaving in a separate mailbox) with a notice affixed to the front door if necessary, drawing the recipient's attention to the fact that the package contains a court order. If the premises do not have a letterbox, or mailbox, or the package will not fit through the letterbox, a package may be left next to the front door and a notice containing this Order may be affixed to the front door marked with a notice drawing the recipient's attention to the fact that the package contains a court order and Claim Form and should be read urgently. The notices shall be given in the form set out in Schedule 2 to this Order; and
- 4.4 **Text messages:** sending a text message to any named Defendant for whom the Claimants have a mobile telephone number, notifying them that an injunction order has been granted against them with a power of arrest, and providing a web link at which the Defendant can access the Claim Form, Application for an Interim Injunction, the supporting documents relied on in this Claim, and this Order. The notice shall be given in the form set out in Schedule 2 to this Order; and
- 4.5 **Placing signs:** on A-Road entry points and exit points to the administrative area of Thurrock, and within 50 metres of The Fuel Terminals and on the A130 and B1014 between the entrance to Canvey Island and the roundabout known as the Waterside Road roundabout on Canvey Island, stating that there is a High Court Injunction in place prohibiting protest on the highway and providing a web link and QR code at which the Claim Form, Application for an Interim Injunction, the supporting documents relied on in this Claim, and this Order and the power of arrest can be accessed; or
- 4.6 **Where requested:** the Claim Form, Application for an Interim Injunction, the supporting documents relied on in this Claim, and this Order and the power of arrest may be served by email where the Defendant has requested that they be served by email and by sending the email to the address provided by the Defendant; or
- 4.7 **Lawyers:** By serving any solicitor acting for a Defendant who has filed a notice of acting in these proceedings.

5. The **deemed date of service** of any documents referred to in paragraph 4 above shall be the day on which service of the document or documents is completed in accordance with paragraph 4 above.
6. Pursuant to CPR rules 6.15 and 6.27, the Claimants shall have permission to serve the **223rd to the 229th Defendants** with the Claim Form, Application for an Interim Injunction, the supporting documents relied on in this Claim, and this Order and the power of arrest by the methods in paragraphs 4.1, 4.2 and 4.5 above (to be read conjunctively).
7. The **deemed date of service** of any of the documents referred to in paragraph 6 above shall be the day on which service of the document or documents is completed in accordance with paragraph 6 above.
8. The Defendants shall acknowledge service of the Claim Form 21 days after the deemed date of service and file any written evidence in support of the Defence by the same date.

Further directions

9. The Defendants or any other person affected by this order may apply to the Court at any time to vary or discharge it but if they wish to do so they must inform the Claimants' solicitors at the same time as the application is filed at court (and in any event not less than 48 hours before the hearing of any such application, not to include weekends or public holidays).
10. Any person applying to vary or discharge this order must provide their full name and address, an address for service, and must also apply to be joined as a named defendant to the proceedings at the same time (to the extent they are not already so named).
11. The Claimant has permission to apply to extend or vary this Order or for further directions. The Claimant must serve any such application on those Defendants who have acknowledged service and provided an address for service.

Final hearing

12. The Claimants shall write to the Court within 28 days of judgment in the appeal of *Wolverhampton City Council & Ors v London Gypsies and Travellers & Ors* (UKSC 2022/0046) being handed down (i) to inform the Court that judgment has been handed down and (ii) proposing directions to bring this Claim to final hearing. The Claimants shall copy that correspondence and the proposed directions to any Defendant who has acknowledged service of the Claim and provided an address for service.

Costs

13. Costs in the case.

GUIDANCE NOTES

Effect of this Order – the Defendants

1. A Defendant who is an individual and who is ordered not to do something must not do it him or herself or in any other way nor must he/she do it through others acting on his/her behalf or on his/her instructions or with his/her encouragement.

Interpretation of this Order

2. In this Order references to ‘the Defendant’ means any or all of them (unless expressly stated otherwise).
3. A requirement to serve on ‘Defendant’ means on each of them. However, the Order is effective against any Defendant on whom it is served in accordance with this Order.
4. An Order requiring ‘the Defendant’ not to do anything applies to all Defendants.
5. This Order contains the following schedules and annexes
 - (i) Schedule A-Undertakings;
 - (ii) Schedule B-Witness Statements;
 - (iii) Schedule 1-List of Named Defendants;
 - (iv) Schedule 2-Notices;
 - (v) Schedule 3-The Power of Arrest;
 - (vi) Annexe 1-The List of “The Roads” in Thurrock;
 - (vii) Annexe 2-The map of the Administrative Area of Thurrock; and
 - (viii) Annexe 3-The map of the Administrative Area of Essex.

Communications with the Court

6. All communications with the Court about this Order should be sent to Room E03, The Royal Courts of Justice, Strand, London, WC2A 2LL. The telephone number is 020 3938957. The offices are open between 10am and 4pm Monday to Friday.

SCHEDULE A-UNDERTAKINGS

1. The Claimants undertake to use reasonable endeavours to personally serve the named Defendants with a copy of this Order. In the event of alternative service, with the exception of paragraph 4.5 above, such shall be effected within 28 days of the date of this order.
2. The Claimants undertake to identify and name Defendants and apply to add them as named Defendants to this Order and the Claim as soon as reasonably practicable.

3. The Claimants undertake to amend within 14 days of this Order the second substantive sentence of the signs referred to in paragraph 4.5 of the Injunction Order above to read “PROTESTING ON THE HIGHWAY IS SUBJECT TO RESTRICTIONS AND THERE ARE SITES PROTECTED BY THE INJUNCTION”.

SCHEDULE B-WITNESS STATEMENTS

1. The Court read the following witness statements filed on behalf of the Claimants:
 - (a) The witness statement of Adewale Adesina 23.4.2022;
 - (b) The witness statement of Morgan Cronin 23.4.2022;
 - (c) The witness statement of Paul Crick 23.4.2022;
 - (d) The first witness statement of Adam Rulewski 24.4.2022;
 - (e) The second witness statement of Adam Rulewski dated 11.5.2022;
 - (f) The third witness statement of Adam Rulewski dated 16.5.2022;
 - (g) The fourth witness statement of Adam Rulewski dated 25.1.2023.

2. The Court read the following witness statements filed on behalf of the Sixty-Third Defendant:
 - (a) The first witness statement of Alice Hardy dated 9.5.2022;
 - (b) The witness statement of Ella Eason dated 9.5.2022;
 - (c) The witness statement of Jessica Branch dated 9.5.2022;
 - (d) The second witness statement of Alice Hardy dated 13.5.2022;
 - (e) The third witness statement of Alice Hardy dated 16.5.2022.

SCHEDULE 1-NAMED DEFENDANTS

1. Madeline Adams
2. Mary Adams
3. David Addy
4. Amber Alexandar
5. Mina-Mae Alexander
6. Eric Anderson
7. Christine Aslett
8. Nicholas Aslett
9. Lachlan Ayles
10. Stephanie Aylett
11. Pete Bailey
12. William Bajwa
13. Jeremy Banks
14. Colin Barrington
15. Kai Bartlett
16. Joshua Bates
17. Christopher Bennett
18. Gillian Bird
19. John Blanco
20. John Blewett
21. Poppy Bliss
22. Hilary Bond
23. Trevor Boulden
24. Geoffroy Bowman
25. Simon Bramwell
26. Joseph Bream
27. Scott Breen
28. Stephen Brett
29. Emily Brocklebank
30. Claire Brook
31. Emma Brooker
32. Michael Brown
33. Judith Bruce
34. Madeleine Budd
35. Tes Burns
36. Benjamin Buse
37. Catherine Cannon
38. Rebecca Cassar
39. Jessica Causby
40. Susan Chamberlayne
41. Sally Chapman
42. Vishal Chauhan
43. Katherine Chesterman
44. Phillipa Clarke
45. Oliver Clegg
46. Orla Coghlan
47. John Coghlan
48. Ruth Cook

49. Heather Cooper
50. Jasmine Corkhill Harris
51. Joy Susan Corrigan
52. Richard Crane
53. David Crawford
54. Rosemary Croft
55. Joseph Daldorph
56. Beverley Ann Daniel
57. Ben Delap
58. Gaie Delap
59. Gabriella Ditton
60. Igors Djomins
61. Laura Doehlei
62. Marguerite Doubleday
63. Ella Eason
64. Christine Essex
65. Janet Flynn
66. Michael Forton
67. Phoebe Frewer
68. Amy Friel
69. Robin Gardner
70. Cressida Gething
71. Alasdair Gibson
72. Hugo Glashier
73. Stephanie Golder
74. William Goldring
75. Xavier Gonzalez Trimmer
76. Alfie Goodland
77. Emma-Rose Goodwin
78. Sophie Greenland
79. Aaron Gunning
80. Louisa Hadden
81. Catherine Hallett
82. Finn Halsall
83. Jake Handling
84. Gareth Harper
85. Louise Harris
86. Patrick Hart
87. Yvonne Hayward
88. Selma Heimedinger
89. Jonathan Herbert
90. Noah Herfort
91. Suzanne Hetherington
92. Sarah Hirons
93. Rupert Horlick
94. Adrian Howlett
95. Eric Hoyland
96. Abigail Hubbucks
97. Hannah Hunt
98. Emma Ireland

99. Pavel Ivanov
100. Rik Jansen
101. Ruth Jarman
102. Stephen Jarvis
103. Russell Jarvis
104. John Johnson
105. Hannah Johnston
106. Timothy Jones
107. Pascale Kann
108. Hallum Kelly
109. Linda Latter
110. Charles Laurie
111. Peter Lay
112. Eben Lazarus
113. Isobel Lewis
114. Elanor Lewis-Holmes
115. Joseph Linheart
116. El Litten
117. Rebecca Lockyer
118. Felix Lozano
119. Barbara Lund
120. Jacqueline Macey
121. Catharine Maclean
122. Jacob Main
123. Elizabeth McCormack
124. Eilidh McFadden
125. Nathan McGovern
126. Louis McKechnie
127. Lilah McKim
128. Grace McMeekin
129. Adalaide Meaney
130. Anna Middleton
131. Hannah Miles
132. Benjamin Mitchell
133. Darcy Mitchell
134. Deborah Mitchell
135. Teddy Monroe
136. Fiona Moore
137. Stefania Morosi
138. Paul Morozzo
139. Virgenia Morris
140. Paul Morrison
141. Zak Mullen
142. Alexandra Mulvey
143. Reuben Mychalecky
144. Richard Newell-Price
145. Ben Newman
146. Alexander Newnham
147. Jessica Norgard
148. Rachel Norris

149. Rose Norris
150. George Oakenfold
151. Nicholas Onley
152. Jakub Pabiniak
153. Ella-Rose Paez
154. Sophie Page-Hall
155. Susan Parfitt
156. Dillon Parsons
157. Rose Patterson
158. Ethan Paul
159. Rosalind Pears
160. Abigail Percy-Ratcliff
161. Ursula Pethick
162. Jacqueline Phillips
163. Mitchel Phillips-White
164. Robert Possnett
165. Matthew Powell
166. Emily Price
167. Robert Price
168. Amy Pritchard
169. Felix Reeves-Whymark
170. Anna Retallack
171. Anne Richards
172. Bethan Roberts
173. Jasmin Robertson
174. Sebastian Roblyn
175. Isabel Rock
176. Elizabeth Rosser
177. Christian Rowe
178. Finn Roweth
179. Adelheid Russenberger
180. Isla Sandford
181. Daniel Sargison
182. James Sargison
183. Cat Scothorne
184. James Sebley
185. Rosa Sharkey
186. Sophie Sharples
187. Susan Sidey
188. James Skeet
189. Hannah Skwarska
190. Jacqueline Slade
191. Oliver Slaughter
192. David Smartknight
193. Heather Smith
194. Joshua Smyth
195. David Squire
196. Katherine Steer
197. Oliver Stevens
198. Madeleine Stewart

199. Ferdi Suleyman
200. Vivien Talbot
201. Ben Taylor
202. Jacqueline Teggim
203. Zachary Tenquist
204. David Thorneywork
205. Hannah Torrance-Bright
206. Lucy Trinder
207. Morgan Trowland
208. Jan Van Der Knapp
209. Rik Venhoutteghem
210. Sally Webber
211. Leonard Weber
212. Miranda Whelehan
213. Philip White
214. Edred Whittingham
215. Alexander Wilcox
216. Clare Wilson
217. Thomas Winter
218. Carol-Ann Wood
219. Lizia Woolf
220. Amorel Kennedy
221. Grace Lally
222. Morien Morgan

SCHEDULE 2-NOTICES

On the package containing this Order:

“VERY URGENT: THIS PACKAGE CONTAINS AN ORDER OF THE HIGH COURT AND YOU SHOULD READ IT IMMEDIATELY AND SEEK LEGAL ADVICE. IF YOU NEED ANOTHER COPY PLEASE DOWNLOAD IT FROM <https://www.thurrock.gov.uk/protest-injunction> OR CALL 020 7405 4600”

to affix to the front door when the package has been posted through the letterbox or placed in a mailbox:

“VERY URGENT: A PACKAGE HAS BEEN LEFT THAT CONTAINS AN ORDER OF THE HIGH COURT AND YOU SHOULD READ IT IMMEDIATELY AND SEEK LEGAL ADVICE. IF YOU NEED ANOTHER COPY PLEASE DOWLOAD IT FROM <https://www.thurrock.gov.uk/protest-injunction> OR CALL 020 7405 4600”

For service by text message:

“VERY URGENT: A HIGH COURT INJUNCTION ORDER HAS BEEN MADE AGAINST YOU, THE LINK PROVIDED IN THIS TEXT MESSAGE CONTAINS AN ORDER OF THE HIGH COURT AND THE SUPPORTING DOCUMENTS RELIED UPON BY THE CLAIMANTS. YOU SHOULD IMMEDIATELY SEEK LEGAL ADVICE. IF YOU NEED ANOTHER COPY PLEASE CALL 020 7405 4600”

SCHEDULE 3-POWER OF ARREST

Power of arrest

Name of defendant

(1) Madeline Adams
 (2)-(222) Other Named Defendants
 (223)-(229) Persons Unknown (see continuation sheet)

Defendant's address

See attached continuation sheet

Name of court High Court of Justice King's Bench Division	Claim No. QB-2022-001317
--	------------------------------------

Claimant's name (including ref.)
 (1) Thurrock Council
 (2) Essex County Council

Defendant's name (including ref.)
 (1) Madeline Adams
 (2)-(222) Other Named Defendants
 (223)-(229) Persons Unknown



Date order made 26/01/2023

Name of judge Mrs Justice Foster DBE

Order made under (insert statutory provision)

Local Government Act 1972, s222 and Highways Act 1980, s130(5)

This order includes a power of arrest under (Insert statutory provision)

Police and Justice Act 2006, s27

The relevant paragraphs of the order to which a power of arrest has been attached are:

(set out those paragraphs of the order to which the power of arrest is attached, if necessary continue on a separate sheet)

Paragraphs 2.1 to 2.16 of the Order of Mrs Justice Foster dated 26 January 2023 (see attached continuation sheet)

This power of arrest was ordered on 26/01/2023 and expires on the 27/05/2024

Note to Arresting Officer

Where the defendant is arrested under the power given by section 155 of the Housing Act 1996, or section 27 of the Police and Justice Act 2006; or section 43 of the Policing and Crime Act 2009; or section 4 of the Anti-Social Behaviour, Crime and Policing Act 2014:-

- the defendant shall be brought before the judge within the period of 24 hours beginning at the time of their arrest;
- a constable shall inform the person on whose application the injunction was granted, forthwith where the defendant is arrested under the power given by section 155 of the Housing Act 1996 or as soon as reasonably practicable where the defendant is arrested under the power given by section 27 of the Police and Justice Act 2006 or section 43 of the Policing and Crime Act 2009 or section 4 of the Anti-Social Behaviour, Crime and Policing Act 2014.

Nothing in section 155 of the Housing Act 1996 or section 27 of the Police and Justice Act 2006 or section 43 of the Policing and Crime Act 2009 or section 4 of the Anti-Social Behaviour, Crime and Policing Act 2014, shall authorise the detention of the respondent after the expiry of the period of 24 hours beginning at the time of their arrest.

In calculating any period of 24 hours, no account shall be taken of Christmas Day, Good Friday or any Sunday.

Name of Claimant

(1) Thurrock Council
 (2) Essex Council

Claimant's address

Sharpe Pritchard LLP
 Elm Yard
 10-16 Elm Street
 London
 WC1X 0BJ

Claimant's phone number

020 7405 4600

In the matter of an application for an injunction made pursuant to the Local Government Act 1972, s222 and the Highways Act 1980, s130(5)

26 January 2023
Before Mrs Justice Foster DBE

B E T W E E N :

(1) THURROCK COUNCIL

(2) ESSEX COUNTY COUNCIL

Claimants

-and-

(1) MADELINE ADAMS

(2)-(222) OTHER NAMED DEFENDANTS AS LISTED AT SCHEDULE 1 TO THE CLAIM FORM

(223) PERSONS UNKNOWN, WHO ARE FOR THE PURPOSE OF PROTESTING, CAUSING THE BLOCKING, ENDANGERING, SLOWING DOWN, OBSTRUCTING, PREVENTING OR OTHERWISE INTERFERING WITH THE FREE FLOW OF TRAFFIC ON TO, OFF OR ALONG THE ROADS LISTED AT ANNEXE 1 TO THE CLAIM FORM

(224) PERSONS UNKNOWN, WHO ARE FOR THE PURPOSE OF PROTESTING, AND WITHOUT THE PERMISSION OF THE REGISTERED KEEPER OF THE VEHICLE, ENTERING, CLIMBING ON, CLIMBING INTO, CLIMBING UNDER, OR IN ANY WAY AFFIXING THEMSELVES OR AFFIXING ANY ITEM TO ANY VEHICLE TRAVELLING ON TO, OFF, ALONG OR WHICH IS ACCESSING OR EXITING THE ROADS LISTED AT ANNEXE 1 TO THE CLAIM FORM

(225) PERSONS UNKNOWN, WHO ARE FOR THE PURPOSE OF PROTESTING, CAUSING THE BLOCKING, ENDANGERING, SLOWING DOWN, OBSTRUCTING, PREVENTING OR OTHERWISE INTERFERING WITH VEHICULAR ACCESS TO, INTO OR OFF ANY PETROL STATION OR ITS FORECOURT WITHIN THE ADMINISTRATIVE AREA OF THURROCK (AS MARKED ON THE MAP AT ANNEXE 2 TO THE CLAIM FORM)

(226) PERSONS UNKNOWN, WHO ARE FOR THE PURPOSE OF PROTESTING, CAUSING THE BLOCKING, ENDANGERING, SLOWING DOWN, OBSTRUCTING, PREVENTING OR OTHERWISE INTERFERING WITH VEHICULAR ACCESS TO OR FROM ANY PETROL STATION OR ITS

FORECOURT WITHIN THE ADMINISTRATIVE AREA OF ESSEX (AS MARKED ON THE MAP AT ANNEXE 3 TO THE CLAIM FORM)

(227) PERSONS UNKNOWN, WHO ARE FOR THE PURPOSE OF PROTESTING, BLOCKING, PREVENTING OR OTHERWISE INTERFERING WITH THE OFFLOADING BY DELIVERY TANKERS OF FUEL SUPPLIES AND/OR THE REFUELLING OF VEHICLES AT ANY PETROL STATION WITHIN THE ADMINISTRATIVE AREA OF THURROCK (AS MARKED ON THE MAP AT ANNEXE 2 TO THE CLAIM FORM)

(228) PERSONS UNKNOWN, WHO ARE FOR THE PURPOSE OF PROTESTING, BLOCKING, PREVENTING OR OTHERWISE INTERFERING WITH THE OFFLOADING BY DELIVERY TANKERS OF FUEL SUPPLIES AND/OR THE REFUELLING OF VEHICLES AT ANY PETROL STATION WITHIN THE ADMINISTRATIVE AREA OF ESSEX (AS MARKED ON THE MAP AT ANNEXE 3 TO THE CLAIM FORM)

(229) PERSONS UNKNOWN WHO ARE TRESPASSING ON, UNDER OR ADJACENT TO THE ROADS LISTED AT ANNEXE 1 TO THE CLAIM FORM BY UNDERTAKING EXCAVATIONS, DIGGING, DRILLING AND/OR TUNNELLING WITHOUT THE PERMISSION OF THE RELEVANT HIGHWAY AUTHORITY

Defendants

POWER OF ARREST: CONTINUATION SHEET

NAMES AND ADDRESSES OF DEFENDANTS

Surname	Forename	Address	Defendant Number
ADAMS	MADELINE	[REDACTED]	1
ADAMS	MARY	[REDACTED]	2
ADDY	DAVID	[REDACTED]	3
ALEXANDER	AMBER	[REDACTED]	4
ALEXANDER	MINA-MAE	[REDACTED]	5
ANDERSON	ERIC	[REDACTED]	6

ASLETT	NICHOLAS	[REDACTED]	8
ASLETT	CHRISTINE	[REDACTED]	7
AYLES	LACHLAN	[REDACTED]	9
AYLETT	STEPHANIE	[REDACTED]	10
BAILEY	PETE	[REDACTED]	11
BAJWA	WILLIAM	[REDACTED]	12
BANKS	JEREMY	[REDACTED]	13
BARRINGTON	COLIN	[REDACTED]	14
BARTLETT	KAI	[REDACTED]	15
BATES	JOSHUA	[REDACTED]	16
BENNETT	CHRISTOPHER	[REDACTED]	17
BIRD	GILLIAN	[REDACTED]	18
BLANCO	JOHN	[REDACTED]	19
BLEWETT	JOHN	[REDACTED]	20
BLISS	POPPY	[REDACTED]	21
BOND	HILARY	[REDACTED]	22
BOULDEN	TREVOR	[REDACTED]	23
BOWMAN	GEOFFREY	[REDACTED]	24
BRAMWELL	SIMON	[REDACTED]	25
BREAM	JOSEPH	[REDACTED]	26
BREEN	SCOTT	[REDACTED]	27
BRETT	STEPHEN	[REDACTED]	28
BROCKLEBANK	EMILY	[REDACTED]	29
BROOK	CLAIRE	[REDACTED]	30
BROOKER	EMMA	[REDACTED]	31

BROWN	MICHAEL	[REDACTED]	32
BRUCE	JUDITH	[REDACTED]	33
BUDD	MADELEINE	[REDACTED]	34
BURNS	TES	[REDACTED]	35
BUSE	BENJAMIN	[REDACTED]	36
CANNON	CATHERINE	[REDACTED]	37
CASSAR	REBECCA	[REDACTED]	38
CAUSBY	JESSICA	[REDACTED]	39
CHAMBERLAYNE	SUSAN	[REDACTED]	40
CHAPMAN	SALLY	[REDACTED]	41
CHAUHAN	VISHAL	[REDACTED]	42
CHESTERMAN	KATHERINE	[REDACTED]	43
CLARKE	PHILIPPA	[REDACTED]	44
CLEGG	OLIVER	[REDACTED]	45
COGHLAN	ORLA	[REDACTED]	46
COGHLAN	JOHN	[REDACTED]	47
COOK	RUTH	[REDACTED]	48
COOPER	HEATHER	[REDACTED]	49
CORKHILL HARRIS	JASMINE	[REDACTED]	50
CORRIGAN	JOY SUSAN	[REDACTED]	51
CRANE	RICHARD	[REDACTED]	52
CRAWFORD	DAVID	[REDACTED]	53
CROFT	ROSEMARY	[REDACTED]	54

DALDORPH	JOSEPH	[REDACTED]	55
DANIEL	BEVERLEY ANN	[REDACTED]	56
DELAP	BEN	[REDACTED]	57
DELAP	GAIE	[REDACTED]	58
DITTON	GABRIELLA	[REDACTED]	59
DJOMINS	IGORS	[REDACTED]	60
DOEHLEI	LAURA	[REDACTED]	61
DOUBLEDAY	MARGUERITE	[REDACTED]	62
EASON	ELLA	[REDACTED]	63
ESSEX	CHRISTINE	[REDACTED]	64
FLYNN	JANET	[REDACTED]	65
FORTON	MICHAEL	[REDACTED]	66
FREWER	PHOEBE	[REDACTED]	67
FRIEL	AMY	[REDACTED]	68
GARDNER	ROBIN	[REDACTED]	69
GETHING	CRESSIDA	[REDACTED]	70
GIBSON	ALASDAIR	[REDACTED]	71
GLASHIER	HUGO	[REDACTED]	72
GOLDER	STEPHANIE	[REDACTED]	73
GOLDRING	WILLIAM	[REDACTED]	74
GONZALEZ TRIMMER	XAVIER	[REDACTED]	75
GOODLAND	ALFIE	[REDACTED]	76
GOODWIN	EMMA-ROSE	[REDACTED]	77
GREENLAND	SOPHIE	[REDACTED]	78
GUNNING	AARON	[REDACTED]	79
HADDEN	LOUISA	[REDACTED]	80

HALLETT	CATHERINE	[REDACTED]	81
HALSALL	FINN	[REDACTED]	82
HANDLING	JAKE	[REDACTED]	83
HARPER	GARETH	[REDACTED]	84
HARRIS	LOUISE	[REDACTED]	85
HART	PATRICK	[REDACTED]	86
HAYWARD	YVONNE	[REDACTED]	87
HEIMEDINGER	SELMA	[REDACTED]	88
HERBERT	JONATHAN	[REDACTED]	89
HERFORT	NOAH	[REDACTED]	90
HETHERINGTON	SUZANNE	[REDACTED]	91
HIRONS	SARAH	[REDACTED]	92
HORLICK	RUPERT	[REDACTED]	93
HOWLETT	ADRIAN	[REDACTED]	94
HOYLAND	ERIC	[REDACTED]	95
HUBBUCKS	ABIGAIL	[REDACTED]	96
HUNT	HANNAH	[REDACTED]	97
IRELAND	EMMA	[REDACTED]	98
IVANOV	PAVEL	[REDACTED]	99
JANSEN	RIK	[REDACTED]	100
JARMAN	RUTH	[REDACTED]	101
JARVIS	STEPHEN	[REDACTED]	102
JARVIS	RUSSELL	[REDACTED]	103
JOHNSON	JOHN	[REDACTED]	104

JOHNSTON	HANNAH	[REDACTED]	105
JONES	TIMOTHY	[REDACTED]	106
KANN	PASCALE	[REDACTED]	107
KELLY	HALLUM	[REDACTED]	108
LATTER	LINDA	[REDACTED]	109
LAURIE	CHARLES	[REDACTED]	110
LAY	PETER	[REDACTED]	111
LAZARUS	EBEN	[REDACTED]	112
LEWIS	ISOBEL	[REDACTED]	113
LEWIS-HOLMES	ELANOR	[REDACTED]	114
LINHART	JOSEPH	[REDACTED]	115
LITTEN	EL	[REDACTED]	116
LOCKYER	REBECCA	[REDACTED]	117
LOZANO	FELIX	[REDACTED]	118
LUND	BARBARA	[REDACTED]	119
MACEY	JACQUELINE	[REDACTED]	120
MACLEAN	CATHERINE	[REDACTED]	121
MAIN	JACOB	[REDACTED]	122
MCCORMACK	ELIZABETH	[REDACTED]	123
MCFADDEN	EILIDH	[REDACTED]	124
MCGOVERN	NATHAN	[REDACTED]	125
MCKECHNIE	LOUIS	[REDACTED]	126
MCKIM	LILAH	[REDACTED]	127
MCMEEKIN	GRACE	[REDACTED]	128
MEANEY	ADALAIDE	[REDACTED]	129

MIDDLETON	ANNA	[REDACTED]	130
MILES	HANNAH	[REDACTED]	131
MITCHELL	DARCY	[REDACTED]	133
MITCHELL	BENJAMIN	[REDACTED]	132
MITCHELL	DEBORAH	[REDACTED]	134
MONROE	TEDDY	[REDACTED]	135
MOORE	FIONA	[REDACTED]	136
MOROSI	STEFANIA	[REDACTED]	137
MOROZZO	PAUL	[REDACTED]	138
MORRIS	VIRGENIA	[REDACTED]	139
MORRISON	PAUL	[REDACTED]	140
MULLEN	ZAK	[REDACTED]	141
MULVEY	ALEXANDRA	[REDACTED]	142
MYCHALECKYJ	REUBEN	[REDACTED]	143
NEWELL-PRICE	RICHARD	[REDACTED]	144
NEWMAN	BEN	[REDACTED]	145
NEWNHAM	ALEXANDER	[REDACTED]	146
NORGARD	JESSICA	[REDACTED]	147
NORRIS	RACHEL	[REDACTED]	148
NORRIS	ROSE	[REDACTED]	149
OAKENFOLD	GEORGE	[REDACTED]	150
ONLEY	NICHOLAS	[REDACTED]	151
PABINIAK	JAKUB	[REDACTED]	152
PAEZ	ELLA-ROSE	[REDACTED]	153

PAGE HALL	SOPHIE	[REDACTED]	154
PARFITT	SUSAN	[REDACTED]	155
PARSONS	DILLON	[REDACTED]	156
PATTERSON	ROSE	[REDACTED]	157
PAUL	ETHAN	[REDACTED]	158
PEARS	ROSALIND	[REDACTED]	159
PERCY-RATCLIFF	ABIGAIL	[REDACTED]	160
PETHICK	URSULA	[REDACTED]	161
PHILLIPS	JACQUELINE	[REDACTED]	162
PHILLIPS-WHITE	MITCHEL	[REDACTED]	163
POSSNETT	ROBERT	[REDACTED]	164
POWELL	MATTHEW	[REDACTED]	165
PRICE	ROBERT	[REDACTED]	167
PRICE	EMILY	[REDACTED]	166
PRITCHARD	AMY	[REDACTED]	168
REEVES-WHYMARK	FELIX	[REDACTED]	169
RESTALLACK	ANNA	[REDACTED]	170
RICHARDS	ANNE	[REDACTED]	171
ROBERTS	BETHAN	[REDACTED]	172
ROBERTSON	JASMIN	[REDACTED]	173
ROBLYN	SEBASTIAN	[REDACTED]	174
ROCK	ISABEL	[REDACTED]	175

ROSSER	ELIZABETH	[REDACTED]	176
ROWE	CHRISTIAN	[REDACTED]	177
ROWETH	FINN	[REDACTED]	178
RUSSENBERGER	ADELHEID	[REDACTED]	179
SANDFORD	ISLA	[REDACTED]	180
SARGISON	DANIEL	[REDACTED]	181
SARGISON	JAMES	[REDACTED]	182
SCOTHORNE	CAT	[REDACTED]	183
SEBLEY	JAMES	[REDACTED]	184
SHARKEY	ROSA	[REDACTED]	185
SHARPLES	SOPHIE	[REDACTED]	186
SIDEY	SUSAN	[REDACTED]	187
SKEET	JAMES	[REDACTED]	188
SKWARSKA	HANNAH	[REDACTED]	189
SLADE	JACQUELINE	[REDACTED]	190
SLAUGHTER	OLIVER	[REDACTED]	191
SMARTKNIGHT	DAVID	[REDACTED]	192
SMITH	HEATHER	[REDACTED]	193
SMYTH	JOSHUA	[REDACTED]	194
SQUIRE	DAVID	[REDACTED]	195
STEER	KATHERINE	[REDACTED]	196
STEVENS	OLIVER	[REDACTED]	197
STEWART	MADELEINE	[REDACTED]	198

SULEYMAN	FERDI	[REDACTED]	199
TALBOT	VIVIEN	[REDACTED]	200
TAYLOR	BEN	[REDACTED]	201
TEGGIN	JACQUELINE	[REDACTED]	202
TENQUIST	ZACHARY	[REDACTED]	203
THORNEYWORK	DAVID	[REDACTED]	204
TORRANCE-BRIGHT	HANNAH	[REDACTED]	205
TRINDER	LUCY	[REDACTED]	206
TROWLAND	MORGAN	[REDACTED]	207
VAN DER KNAAP	JAN	[REDACTED]	208
VANHOUTTEGHEM	RIK	[REDACTED]	209
WEBBER	SALLY	[REDACTED]	210
WEBER	LEONARD	[REDACTED]	211
WHELEHAN	MIRANDA	[REDACTED]	212
WHITE	PHILIP	[REDACTED]	213
WHITTINGHAM	EDRED	[REDACTED]	214
WILCOX	ALEXANDER	[REDACTED]	215
WILSON	CLARE	[REDACTED]	216
WINTER	THOMAS	[REDACTED]	217
WOOD	CAROL-ANN	[REDACTED]	218
WOOLF	LIZIA	[REDACTED]	219

KENNEDY	AMOREL		220
LALLY	GRACE		221
MORGAN	MORIEN		222
PERSONS UNKNOWN, WHO ARE FOR THE PURPOSE OF PROTESTING, CAUSING THE BLOCKING, ENDANGERING, SLOWING DOWN, OBSTRUCTING, PREVENTING OR OTHERWISE INTERFERING WITH THE FREE FLOW OF TRAFFIC ON TO, OFF OR ALONG THE ROADS LISTED AT ANNEXE 1 TO THE CLAIM FORM			223
PERSONS UNKNOWN, WHO ARE FOR THE PURPOSE OF PROTESTING, AND WITHOUT THE PERMISSION OF THE REGISTERED KEEPER OF THE VEHICLE, ENTERING, CLIMBING ON, CLIMBING INTO, CLIMBING UNDER, OR IN ANY WAY AFFIXING THEMSELVES OR AFFIXING ANY ITEM TO ANY VEHICLE TRAVELLING ON TO, OFF, ALONG OR WHICH IS ACCESSING OR EXITING THE ROADS LISTED AT ANNEXE 1 TO THE CLAIM FORM			224
PERSONS UNKNOWN, WHO ARE FOR THE PURPOSE OF PROTESTING, CAUSING THE BLOCKING, ENDANGERING, SLOWING DOWN, OBSTRUCTING, PREVENTING OR OTHERWISE INTERFERING WITH VEHICULAR ACCESS TO, INTO OR OFF ANY PETROL STATION OR ITS FORECOURT WITHIN THE ADMINISTRATIVE AREA OF THURROCK (AS MARKED ON THE MAP AT ANNEXE 2 TO THE CLAIM FORM)			225
PERSONS UNKNOWN, WHO ARE FOR THE PURPOSE OF PROTESTING, CAUSING THE BLOCKING, ENDANGERING, SLOWING DOWN, OBSTRUCTING, PREVENTING OR OTHERWISE INTERFERING WITH VEHICULAR ACCESS TO OR FROM ANY PETROL STATION OR ITS FORECOURT WITHIN THE ADMINISTRATIVE AREA OF ESSEX (AS MARKED ON THE MAP AT ANNEXE 3 TO THE CLAIM FORM)			226
PERSONS UNKNOWN, WHO ARE FOR THE PURPOSE OF PROTESTING, BLOCKING, PREVENTING OR OTHERWISE INTERFERING WITH THE OFFLOADING BY DELIVERY TANKERS OF FUEL SUPPLIES AND/OR THE REFUELLING OF VEHICLES AT ANY PETROL STATION WITHIN THE ADMINISTRATIVE AREA OF THURROCK (AS MARKED ON THE MAP AT ANNEXE 2 TO THE CLAIM FORM)			227
PERSONS UNKNOWN, WHO ARE FOR THE PURPOSE OF PROTESTING, BLOCKING, PREVENTING OR OTHERWISE INTERFERING WITH THE OFFLOADING BY DELIVERY TANKERS OF FUEL SUPPLIES AND/OR THE REFUELLING OF VEHICLES AT ANY PETROL STATION WITHIN THE ADMINISTRATIVE AREA OF ESSEX (AS MARKED ON THE MAP AT ANNEXE 3 TO THE CLAIM FORM)			228
PERSONS UNKNOWN WHO ARE TRESPASSING ON, UNDER OR ADJACENT TO THE ROADS LISTED AT ANNEXE 1 TO THE CLAIM FORM BY UNDERTAKING EXCAVATIONS, DIGGING, DRILLING AND/OR TUNNELLING WITHOUT THE PERMISSION OF THE RELEVANT HIGHWAY AUTHORITY			229

THE RELEVANT PARAGRAPHS OF THE ORDER TO WHICH A POWER OF ARREST HAVE BEEN ATTACHED ARE:

Paragraphs 2.1 to 2.16 of the Order of Mrs Justice Foster DBE dated 26 January 2023:

2. The Defendants and each of them (whether by themselves or by instructing, encouraging or allowing any other person) are forbidden from:
 - 2.1 Blocking, slowing down, endangering, obstructing or otherwise interfering with the flow of traffic onto or along or off the Roads for the purpose of protesting.
 - 2.2 Blocking, slowing down, endangering, obstructing or otherwise interfering with access to or from the Roads, and on any adjacent roads, slip roads or roundabouts which are not vested in the Claimants, for the purpose of protesting.
 - 2.3 Entering, climbing onto, climbing into, climbing under any vehicle travelling on to, off or along the Roads or accessing or exiting the Roads: (a) without the permission of the registered keeper of the vehicle; and (b) for the purpose of protesting.
 - 2.4 Entering, climbing onto, climbing into, climbing under any vehicle on any adjacent roads, slip roads or roundabouts to the Roads, whether or not those roads are vested in the Claimants: (a) without the permission of the registered keeper of the vehicle; and (b) for the purpose of protesting.
 - 2.5 Affixing themselves (“locking on”) to any vehicle travelling on to, off or along the Roads or accessing or exiting the Roads.
 - 2.6 Affixing themselves (“locking on”) to any vehicle on any adjacent roads, slip roads or roundabouts to the Roads, whether or not those roads are vested in the Claimants, where the “locking on” is for the purpose of protesting.
 - 2.7 Affixing themselves (“locking on”) or any other items to any of the Roads or any other person or object on, under or over the Roads.
 - 2.8 Affixing themselves (“locking on”) or any other items to any adjacent roads, slip roads or roundabouts to the Roads, whether or not those roads are vested in the Claimants where the “locking on” is for the purpose of protesting.
 - 2.9 Erecting any structure on the Roads.
 - 2.10 Tunnelling, excavating, drilling or digging under or adjacent to the Roads.
 - 2.11 Occupying existing tunnels under the Roads for the purpose of protesting.
 - 2.12 Causing damage to the surface of or to any apparatus on or adjacent to the Roads or any vehicle on the Roads for the purpose of protesting.
 - 2.13 Abandoning any vehicle or item on any Roads, adjacent roads, slip roads or roundabouts to the Roads, whether or not those roads are vested in the Claimants for the purpose of protesting.

- 2.14 Blocking, slowing down, obstructing or otherwise interfering with vehicular access to any petrol station in the administrative areas of Thurrock and Essex for the purpose of protesting.
- 2.15 Blocking, endangering, slowing down, obstructing or otherwise interfering with vehicular access to any petrol station forecourt or access road, in the administrative areas of Thurrock and Essex for the purpose of protesting.
- 2.16 Blocking, endangering, slowing down, obstructing or otherwise interfering with the offloading by delivery tankers of fuel supplies and/or the refuelling of vehicles at any petrol station within the administrative areas of Thurrock and Essex.

In the matter of an application for an injunction made pursuant to the Local Government Act 1972, s222 and the Highways Act 1980, s130(5)

26 January 2023
Before Mrs Justice Foster DBE

B E T W E E N :

(1) THURROCK COUNCIL

(2) ESSEX COUNTY COUNCIL

Claimants

-and-

(1) MADELINE ADAMS

(2)-(222) OTHER NAMED DEFENDANTS AS LISTED AT SCHEDULE 1 TO THE CLAIM FORM

(223) PERSONS UNKNOWN, WHO ARE FOR THE PURPOSE OF PROTESTING, CAUSING THE BLOCKING, ENDANGERING, SLOWING DOWN, OBSTRUCTING, PREVENTING OR OTHERWISE INTERFERING WITH THE FREE FLOW OF TRAFFIC ON TO, OFF OR ALONG THE ROADS LISTED AT ANNEXE 1 TO THE CLAIM FORM

(224) PERSONS UNKNOWN, WHO ARE FOR THE PURPOSE OF PROTESTING, AND WITHOUT THE PERMISSION OF THE REGISTERED KEEPER OF THE VEHICLE, ENTERING, CLIMBING ON, CLIMBING INTO, CLIMBING UNDER, OR IN ANY WAY AFFIXING THEMSELVES OR AFFIXING ANY ITEM TO ANY VEHICLE TRAVELLING ON TO, OFF, ALONG OR WHICH IS ACCESSING OR EXITING THE ROADS LISTED AT ANNEXE 1 TO THE CLAIM FORM

(225) PERSONS UNKNOWN, WHO ARE FOR THE PURPOSE OF PROTESTING, CAUSING THE BLOCKING, ENDANGERING, SLOWING DOWN, OBSTRUCTING, PREVENTING OR OTHERWISE INTERFERING WITH VEHICULAR ACCESS TO, INTO OR OFF ANY PETROL STATION OR ITS FORECOURT WITHIN THE ADMINISTRATIVE AREA OF THURROCK (AS MARKED ON THE MAP AT ANNEXE 2 TO THE CLAIM FORM)

(226) PERSONS UNKNOWN, WHO ARE FOR THE PURPOSE OF PROTESTING, CAUSING THE BLOCKING, ENDANGERING, SLOWING DOWN, OBSTRUCTING, PREVENTING OR OTHERWISE INTERFERING WITH

VEHICULAR ACCESS TO OR FROM ANY PETROL STATION OR ITS FORECOURT WITHIN THE ADMINISTRATIVE AREA OF ESSEX (AS MARKED ON THE MAP AT ANNEXE 3 TO THE CLAIM FORM)

(227) PERSONS UNKNOWN, WHO ARE FOR THE PURPOSE OF PROTESTING, BLOCKING, PREVENTING OR OTHERWISE INTERFERING WITH THE OFFLOADING BY DELIVERY TANKERS OF FUEL SUPPLIES AND/OR THE REFUELLING OF VEHICLES AT ANY PETROL STATION WITHIN THE ADMINISTRATIVE AREA OF THURROCK (AS MARKED ON THE MAP AT ANNEXE 2 TO THE CLAIM FORM)

(228) PERSONS UNKNOWN, WHO ARE FOR THE PURPOSE OF PROTESTING, BLOCKING, PREVENTING OR OTHERWISE INTERFERING WITH THE OFFLOADING BY DELIVERY TANKERS OF FUEL SUPPLIES AND/OR THE REFUELLING OF VEHICLES AT ANY PETROL STATION WITHIN THE ADMINISTRATIVE AREA OF ESSEX (AS MARKED ON THE MAP AT ANNEXE 3 TO THE CLAIM FORM)

(229) PERSONS UNKNOWN WHO ARE TRESPASSING ON, UNDER OR ADJACENT TO THE ROADS LISTED AT ANNEXE 1 TO THE CLAIM FORM BY UNDERTAKING EXCAVATIONS, DIGGING, DRILLING AND/OR TUNNELLING WITHOUT THE PERMISSION OF THE RELEVANT HIGHWAY AUTHORITY

Defendants

ANNEXE 1

Thurrock Council Roads

NORTH ROAD	B186
SANDY LANE	B1335
ROMFORD ROAD ROUNDABOUT	B1335
MILL ROAD	C Class
PURFLEET ROAD	C Class
WEST ROAD	C Class
ARISDALE AVENUE	C Class
DAIGLEN DRIVE	C Class
STIFFORD ROAD	B1335
LANCE CORPORAL NICKY MASON WAY	B1335
STIFFORD ROAD	B1335
ARTERIAL ROAD	A1306
THURROCK SERVICES ROAD	Unclassified
POND ROAD ROUNDABOUT	Unclassified
LONDON ROAD ROUNDABOUT	A1306
LONDON ROAD	A1306
ENTRY ON SLIP WELLINGTON INTERCHANGE TO A13 EASTBOUND	A13
EXIT OFF SLIP A13 TO WELLINGTON INTERCHANGE WESTBOUND	A13
PURFLEET BYPASS	B1335
LINK ROAD FROM A13 SOUTHBOUND TO A1306	A1090
CANTERBURY WAY SLIP ROAD ANTICLOCKWISE	A282
LINK ROAD FROM A1306 TO A13 NORTHBOUND	A282
CANTERBURY WAY SLIP ROAD CLOCKWISE	A282
STONEHOUSE CORNER ROUNDABOUT	A1090
ARTERIAL ROAD ROUNDABOUT	A1090
STONEHOUSE LANE	A1090
CYGNET VIEW	Unclassified
ARTERIAL ROAD ROUNDABOUT A1306	A1306
WEST THURROCK WAY RETAIL PARK ROUNDABOUT	B186
ARTERIAL ROAD	A1306
LAKE RISE	Unclassified
OLIVER CLOSE	A1090
ST CLEMENTS WAY ROUNDABOUT	A1090
ST CLEMENTS WAY	A1090
LONDON ROAD	A1090
WEST THURROCK WAY	A126
Access road Cost Co	Unclassified
JUNCTION 30 M25 TO BOROUGH BOUNDARY WESTBOUND	A13
BOROUGH BOUNDARY TO M25 JUNCTION 30 EASTBOUND	A13
ACCESS ROAD FROM BURGHLEY ROAD TO SUPERSTORE	Private Road
BURGHLEY ROAD ROUNDABOUT	B146
SEALLY ROAD	Unclassified
BURGHLEY ROAD	B146
PILGRIMS LANE ROUNDABOUT	A1306
ARTERIAL ROAD	A1306

ENTRY ON SLIP NORTH SLIFFORD ROUNDABOUT TO A13 EASTBOUND	A13
ENTRY ON SLIP NORTH STIFFORD ROUNDABOUT TO A13 WESTBOUND	A13
EXIT OFF SLIP A13 TO NORTH STIFFORD ROUNDABOUT WESTBOUND	A13
EXIT OFF SLIP A13 TO NORTH STIFFORD ROUNDABOUT EASTBOUND	A13
STIFFORD ROUNDABOUT	A1012
TREACLE MINE ROUNDABOUT	A1012
LINK FROM A1012 ROUNDABOUT TO A1306 INTERCHANGE	A1012
HOGG LANE	A1012
ELIZABETH ROAD	A1012
HOGG LANE ROUNDABOUT	A1012
LONDON ROAD	A126
HOGG LANE ROUNDABOUT	A1012
EASTERN WAY	A126
LAKESIDE INTERCHANGE TO NORTH STIFFORD ROUNDABOUT EASTBOUND	A13
NORTH STIFFORD ROUNDABOUT TO LAKESIDE INTERCHANGE WESTBOUND	A13
LAKESIDE INTERCHANGE TO M25 JUNCTION 30 WESTBOUND	A13
JUNCTION 30 M25 TO LAKESIDE INTERCHANGE EASTBOUND	A13
BRENTWOOD ROAD	A128
STANFORD ROAD	A1013
SOUTHEND ROAD	A1013
CEMENT BLOCK COTTAGES	Unclassified
DOCK ROAD	A126
ORSETT COCK ROUNDABOUT	A1013
ENTRY ON SLIP ORSETT COCK ROUNDABOUT TO A13 WESTBOUND	A13
EXIT OFF SLIP A13 EASTBOUND TO ORSETT COCK ROUNDABOUT	A13
EXIT OFF SLIP A13 WESTBOUND TO ORSETT COCK ROUNDABOUT	A13
DENEHOLES ROUNDABOUT	A1013
WOOD VIEW	B149
LODGE LANE	A1013
CHADWELL HILL	C Class
EXIT OFF SLIP A1089 TO A126 SOUTHBOUND	A1089
ENTRY ON SLIP A126 TO A1089 NORTHBOUND	A1089
MARSHFOOT ROAD ROUNDABOUT	A126
ST CHADS ROAD ROUNDABOUT	A126
GATEWAY ACADEMY ROUNDABOUT MARSHFOOT ROAD	A126
MARSHFOOT ROAD	A126
MARSHFOOT ROAD	A126
BROADWAY	A126
THURROCK PARK WAY	Unclassified
ACCESS ROADS FOR ASDA SUPPERSTORE	Unclassified
NORTH STIFFORD ROUNDABOUT TO A1089 EASTBOUND	A13
A1089 TO NORTH STIFFORD ROUNDABOUT WESTBOUND	A13

A1089 TO ORSETT COCK ROUNDABOUT EASTBOUND	A13
ORSETT COCK ROUNDABOUT TO A1089 WESTBOUND	A13
DOCK APPROACH ROAD	A1089
DOCK APPROACH ROAD	A1089
DOCK APPROACH ROAD	A1089
THURROCK PARK WAY ROUNDABOUT	A1089
SLIP ROAD FROM DOCK APPROACH ROAD TO A13	A13
SLIP ROAD FROM DOCK APPROACH ROAD TO A13	A13
STANFORD ROAD	A1013
LONDON ROAD	C Class
ENTRY ON SLIP ORSETT COCK ROUNDABOUT TO A13 EASTBOUND	A13
Orsett Cock FS West Slip Roads	A13
Orsett Cock FS East Slip Roads	A13
STANFORD ROAD	A1013
STANFORD BYPASS INTERCHANGE	A1014
ENTRY ON SLIP STANFORD INTERCHANGE TO A13 EASTBOUND	A13
EXIT OFF SLIP A13 EASTBOUND TO STANFORD INTERCHANGE	A13
EXIT OFF SLIP A13 WESTBOUND TO STANFORD INTERCHANGE	A13
ENTRY ON SLIP STANFORD INTERCHANGE TO A13 WESTBOUND	A13
SOUTHEND ROAD	B1420
THE MANORWAY SOUTHEND ROAD LINK WESTBOUND	A1014
THE MANORWAY SOUTHEND ROAD LINK EASTBOUND	A1014
THE MANORWAY	A1014
CORRINGHAM ROAD A1014 ROUNDABOUT	A1014
ORSETT COCK ROUNDABOUT TO STANFORD INTERCHANGE EASTBOUND	A13
STANFORD INTERCHANGE TO ORSETT COCK ROUNDABOUT WESTBOUND	A13
STANFORD INTERCHANGE TO BOROUGH BOUNDARY AT FIVE BELLS EASTBOUND	A13
BOROUGH BOUNDARY AT FIVE BELLS TO STANFORD INTERCHANGE WESTBOUND	A13
BELLS CORNER PARADE SOUTHEND ROAD	A176
BELLS CORNER ROUNDABOUT	A176
SOUTHEND ROAD	B1420
LINK ROAD FROM B1420 AND BELLS CORNER ROUNDABOUT TO BOUNDARY	B1420
THE MANORWAY	A1014
GIFFORDS CROSS ROAD	C Class
FOBBING ROAD	C Class
CHURCH ROAD	B1420
LAMPITS HILL	B1420
SOUTHEND ROAD	B1420
ENTRY ON SLIP FIVE BELLS ROUNDABOUT TO A13 WESTBOUND	A13
FIVE BELLS ROUNDABOUT SOUTH	A176
FIVE BELLS ROUNDABOUT NORTH	A176
EXIT OFF SLIP A13 EASTBOUND TO FIVE BELLS ROUNDABOUT	A13
FIVE BELLS SLIP ROAD FROM SOUTHEND ROAD WESTBOUND	A13

ASKEWS FARM LANE	Unclassified
WOULDHAM ROAD	Unclassified
LONDON ROAD	A126
ST CLEMENTS WAY ROUNDABOUT	A1090
BURNLEY ROAD	Unclassified
ST CLEMENTS WAY	A1090
STONEHOUSE CORNER ROUNDABOUT	A1090
SHIP LANE	C Class
ARTERIAL ROAD ROUNDABOUT	A1306
STONEHOUSE LANE	A1090
ARTERIAL ROAD	A1306
LONDON ROAD	A1090
LONDON ROAD	A1090
OLIVER ROAD	A1090
OLIVER CLOSE	A1090
STANFORD BYPASS INTERCHANGE	A1014
CORRINGHAM ROAD A1014 ROUNDABOUT	A1014
THE MANORWAY	A1014
THE MANORWAY	A1014
THE MANORWAY	A1014
ENTRY ON SLIP STANFORD INTERCHANGE TO A13 WESTBOUND	A13
EXIT OFF SLIP A13 EASTBOUND TO STANFORD INTERCHANGE	A13
ENTRY ON SLIP STANFORD INTERCHANGE TO A13 EASTBOUND	A13
EXIT OFF SLIP A13 WESTBOUND TO STANFORD INTERCHANGE	A13
CANTERBURY WAY SLIP ROAD ANTICLOCKWISE	A282
CANTERBURY WAY SLIP ROAD CLOCKWISE	A282
LINK ROAD FROM A13 SOUTHBOUND TO A1306	A13
LINK ROAD FROM A1306 TO A13 NORTHBOUND	A13

Essex County Council Roads

HAVEN ROAD, CANVEY ISLAND
 ROSCOMMON WAY, CANVEY ISLAND
 NORTHWICK ROAD, CANVEY ISLAND
 A130 FROM SADDLERS FARM ROUNDABOUT TO JUNCTION WITH
 HAVEN ROAD
 SADLERS FARM ROUNDABOUT
 SLIPROADS LEADING TO AND FROM A13 FROM SADLERS FARM
 ROUNDABOUT
 SLIPROADS LEADING TO AND FROM A130 FROM SADLERS FARM
 ROUNDABOUT
 B1014 CANVEY ROAD FROM WATERSIDE ROUNDABOUT TO
 ROUNDABOUT ON HIGH STREET BENFLEET

CANVEY ISLAND PUBLIC FOOTPATH NUMBER 8
A130 AND B1014 BETWEEN THE ENTRANCE TO THE ISLAND AND
ROUNDAABOUT KNOWN AS THE WATERSIDE ROAD ROUNDAABOUT

In the matter of an application for an injunction made pursuant to the Local Government Act 1972, s222 and the Highways Act 1980, s130(5)

26 January 2023
Before Mrs Justice Foster DBE

B E T W E E N :

(1) THURROCK COUNCIL

(2) ESSEX COUNTY COUNCIL

Claimants

-and-

(1) MADELINE ADAMS

(2)-(222) OTHER NAMED DEFENDANTS AS LISTED AT SCHEDULE 1 TO THE CLAIM FORM

(223) PERSONS UNKNOWN, WHO ARE FOR THE PURPOSE OF PROTESTING, CAUSING THE BLOCKING, ENDANGERING, SLOWING DOWN, OBSTRUCTING, PREVENTING OR OTHERWISE INTERFERING WITH THE FREE FLOW OF TRAFFIC ON TO, OFF OR ALONG THE ROADS LISTED AT ANNEXE 1 TO THE CLAIM FORM

(224) PERSONS UNKNOWN, WHO ARE FOR THE PURPOSE OF PROTESTING, AND WITHOUT THE PERMISSION OF THE REGISTERED KEEPER OF THE VEHICLE, ENTERING, CLIMBING ON, CLIMBING INTO, CLIMBING UNDER, OR IN ANY WAY AFFIXING THEMSELVES OR AFFIXING ANY ITEM TO ANY VEHICLE TRAVELLING ON TO, OFF, ALONG OR WHICH IS ACCESSING OR EXITING THE ROADS LISTED AT ANNEXE 1 TO THE CLAIM FORM

(225) PERSONS UNKNOWN, WHO ARE FOR THE PURPOSE OF PROTESTING, CAUSING THE BLOCKING, ENDANGERING, SLOWING DOWN, OBSTRUCTING, PREVENTING OR OTHERWISE INTERFERING WITH VEHICULAR ACCESS TO, INTO OR OFF ANY PETROL STATION OR ITS FORECOURT WITHIN THE ADMINISTRATIVE AREA OF THURROCK (AS MARKED ON THE MAP AT ANNEXE 2 TO THE CLAIM FORM)

(226) PERSONS UNKNOWN, WHO ARE FOR THE PURPOSE OF PROTESTING, CAUSING THE BLOCKING, ENDANGERING, SLOWING DOWN, OBSTRUCTING, PREVENTING OR OTHERWISE INTERFERING WITH

VEHICULAR ACCESS TO OR FROM ANY PETROL STATION OR ITS FORECOURT WITHIN THE ADMINISTRATIVE AREA OF ESSEX (AS MARKED ON THE MAP AT ANNEXE 3 TO THE CLAIM FORM)

(227) PERSONS UNKNOWN, WHO ARE FOR THE PURPOSE OF PROTESTING, BLOCKING, PREVENTING OR OTHERWISE INTERFERING WITH THE OFFLOADING BY DELIVERY TANKERS OF FUEL SUPPLIES AND/OR THE REFUELLING OF VEHICLES AT ANY PETROL STATION WITHIN THE ADMINISTRATIVE AREA OF THURROCK (AS MARKED ON THE MAP AT ANNEXE 2 TO THE CLAIM FORM)

(228) PERSONS UNKNOWN, WHO ARE FOR THE PURPOSE OF PROTESTING, BLOCKING, PREVENTING OR OTHERWISE INTERFERING WITH THE OFFLOADING BY DELIVERY TANKERS OF FUEL SUPPLIES AND/OR THE REFUELLING OF VEHICLES AT ANY PETROL STATION WITHIN THE ADMINISTRATIVE AREA OF ESSEX (AS MARKED ON THE MAP AT ANNEXE 3 TO THE CLAIM FORM)

(229) PERSONS UNKNOWN WHO ARE TRESPASSING ON, UNDER OR ADJACENT TO THE ROADS LISTED AT ANNEXE 1 TO THE CLAIM FORM BY UNDERTAKING EXCAVATIONS, DIGGING, DRILLING AND/OR TUNNELLING WITHOUT THE PERMISSION OF THE RELEVANT HIGHWAY AUTHORITY

Defendants

ANNEXE 2

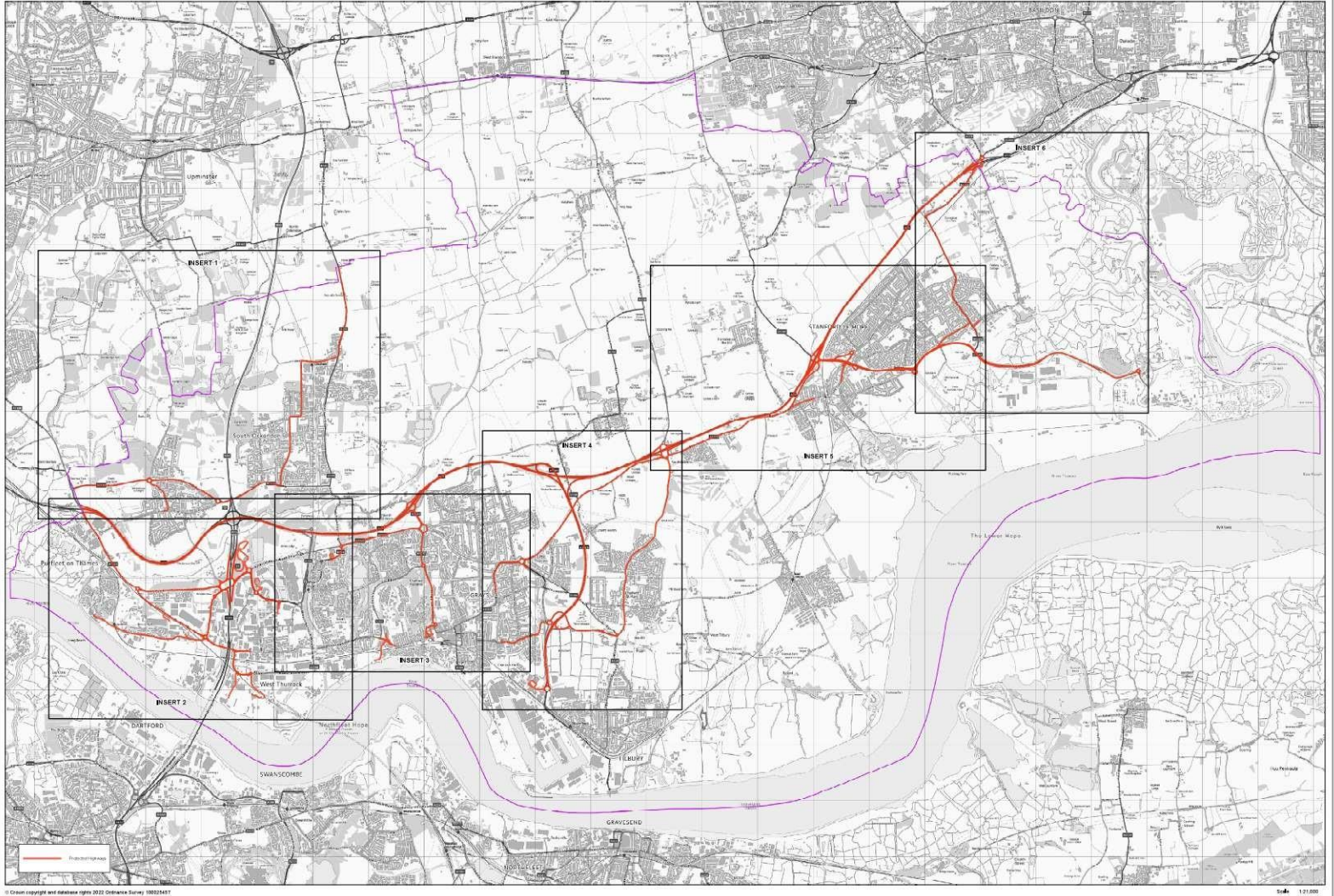

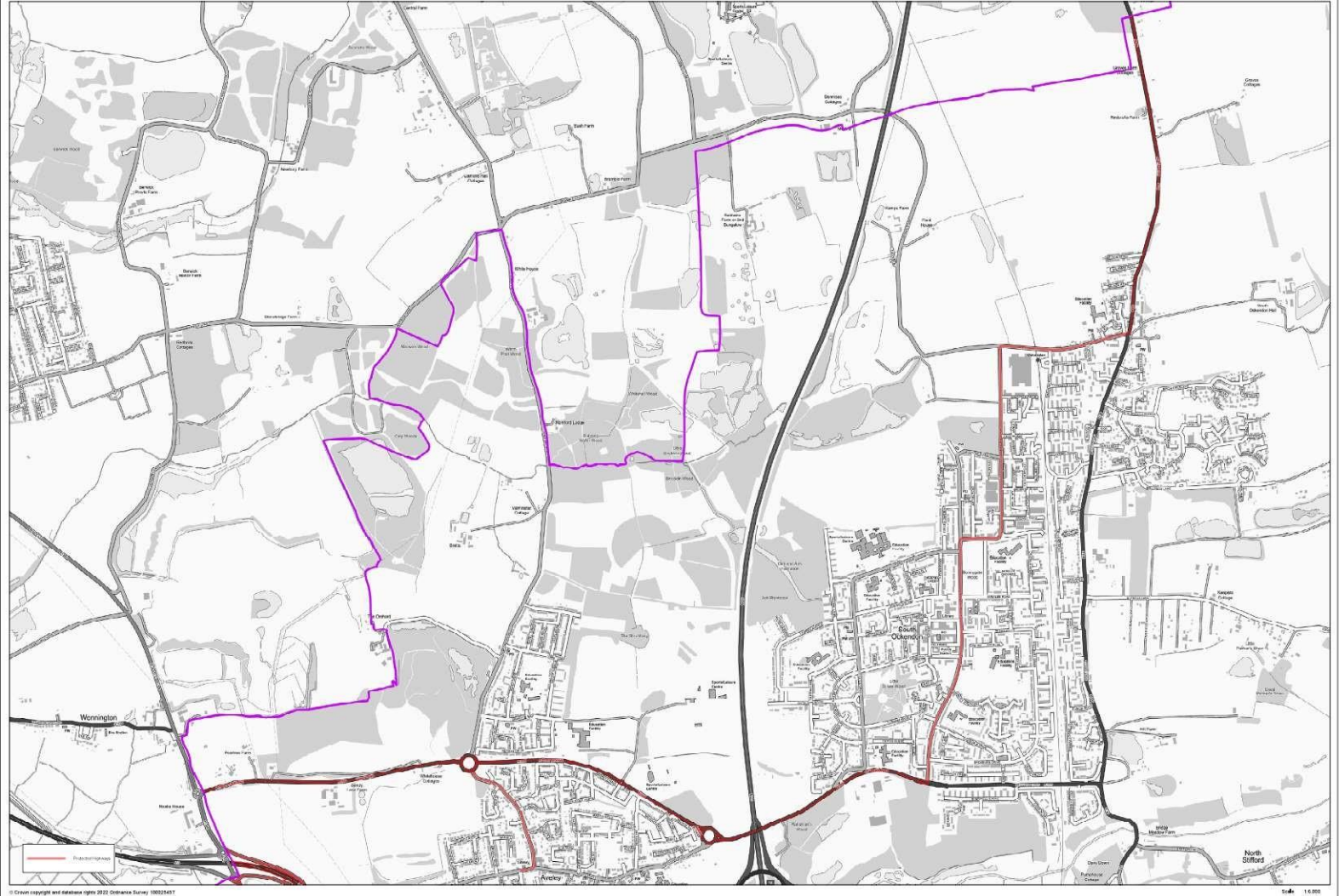

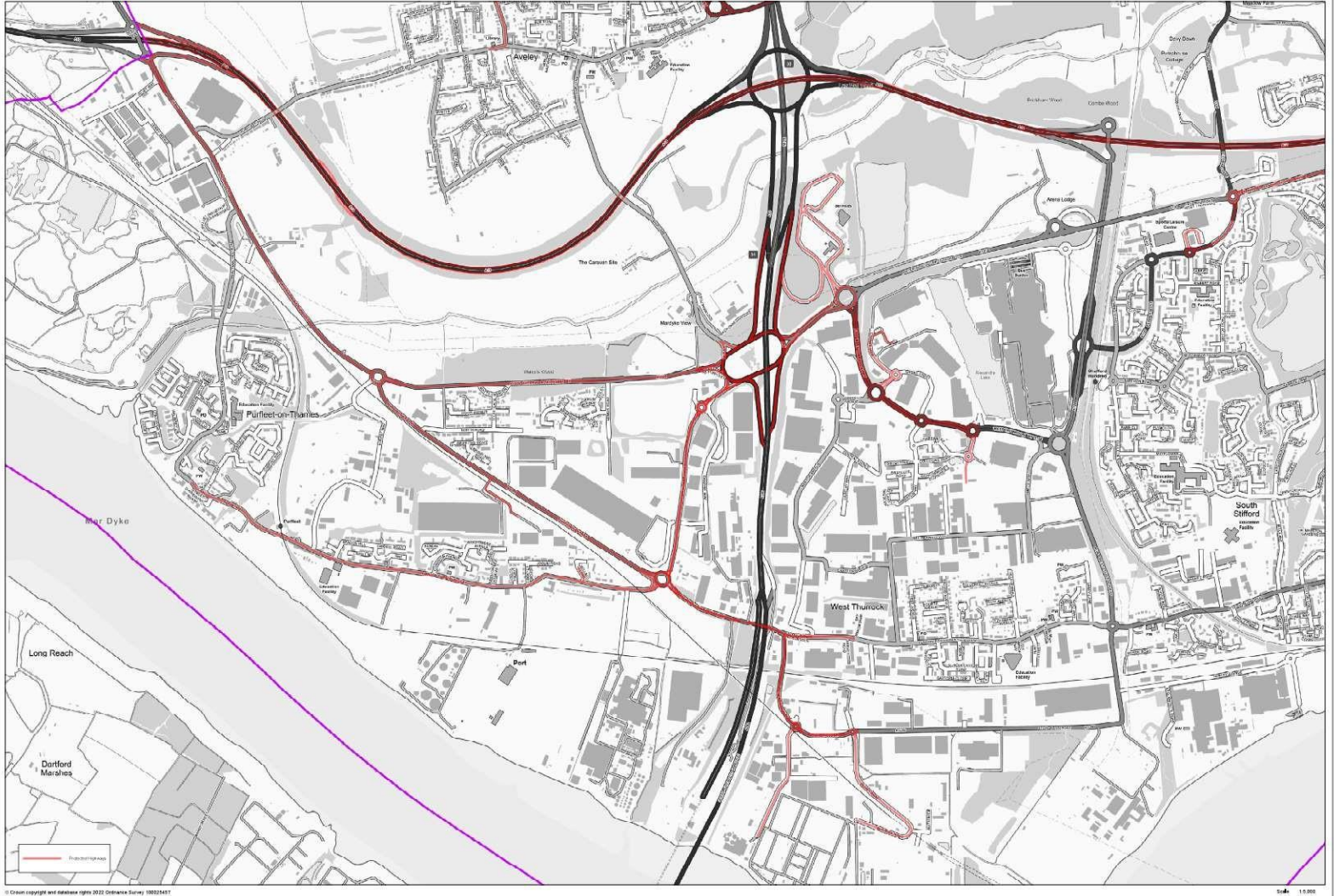

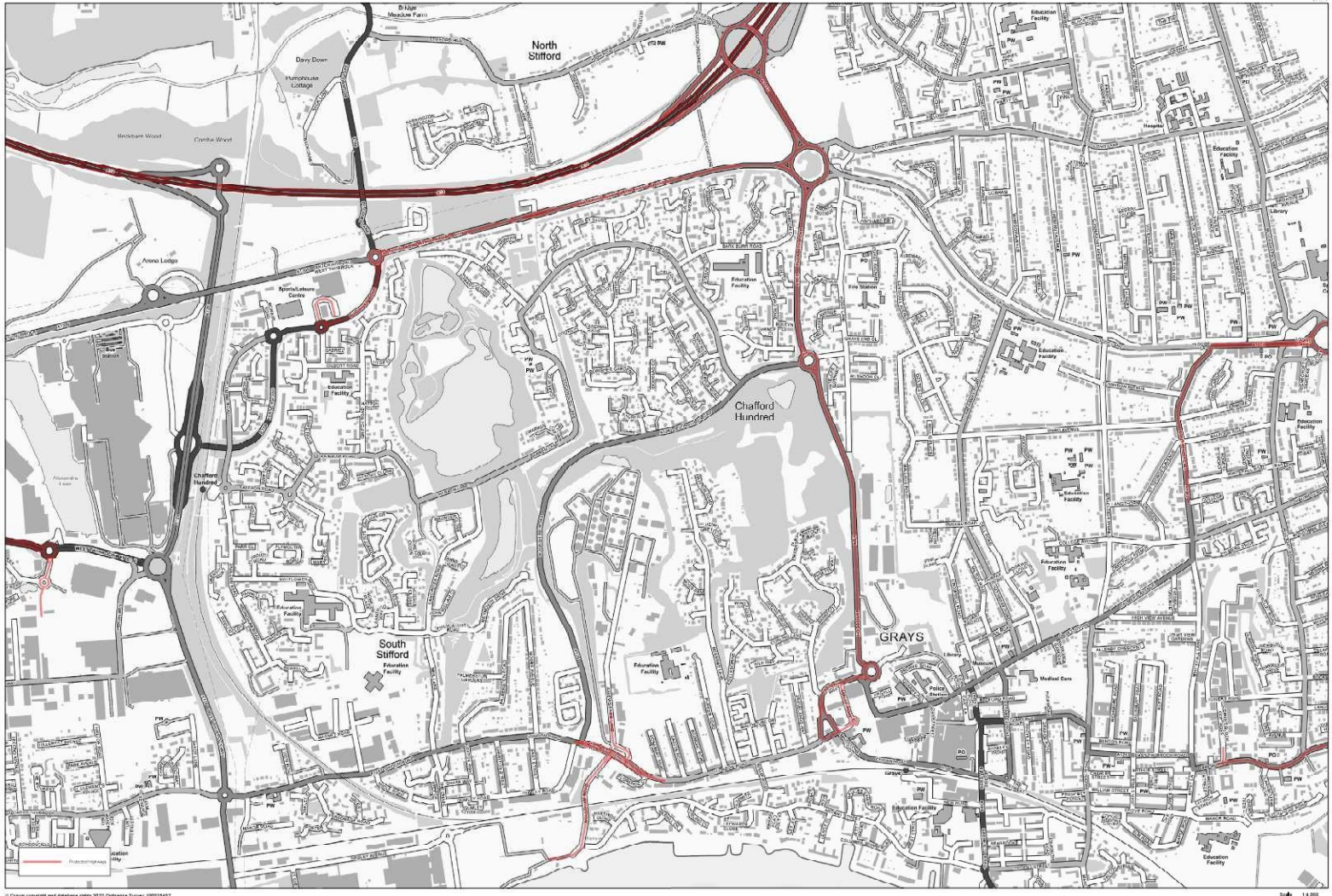





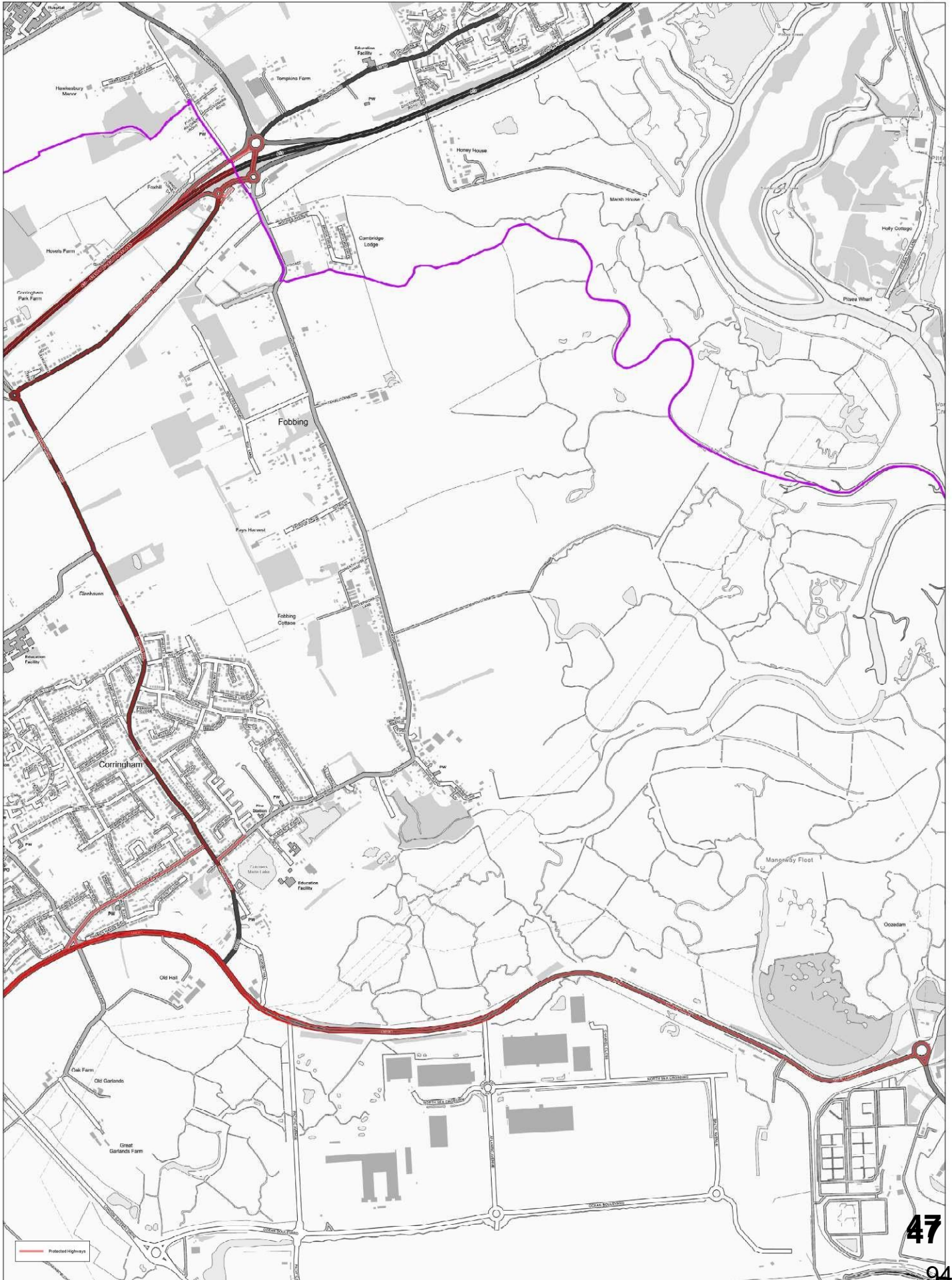

47

In the matter of an application for an injunction made pursuant to the Local Government Act 1972, s222 and the Highways Act 1980, s130(5)

26 January 2023
Before Mrs Justice Foster DBE

B E T W E E N :

(1) THURROCK COUNCIL

(2) ESSEX COUNTY COUNCIL

Claimants

-and-

(1) MADELINE ADAMS

(2)-(222) OTHER NAMED DEFENDANTS AS LISTED AT SCHEDULE 1 TO THE CLAIM FORM

(223) PERSONS UNKNOWN, WHO ARE FOR THE PURPOSE OF PROTESTING, CAUSING THE BLOCKING, ENDANGERING, SLOWING DOWN, OBSTRUCTING, PREVENTING OR OTHERWISE INTERFERING WITH THE FREE FLOW OF TRAFFIC ON TO, OFF OR ALONG THE ROADS LISTED AT ANNEXE 1 TO THE CLAIM FORM

(224) PERSONS UNKNOWN, WHO ARE FOR THE PURPOSE OF PROTESTING, AND WITHOUT THE PERMISSION OF THE REGISTERED KEEPER OF THE VEHICLE, ENTERING, CLIMBING ON, CLIMBING INTO, CLIMBING UNDER, OR IN ANY WAY AFFIXING THEMSELVES OR AFFIXING ANY ITEM TO ANY VEHICLE TRAVELLING ON TO, OFF, ALONG OR WHICH IS ACCESSING OR EXITING THE ROADS LISTED AT ANNEXE 1 TO THE CLAIM FORM

(225) PERSONS UNKNOWN, WHO ARE FOR THE PURPOSE OF PROTESTING, CAUSING THE BLOCKING, ENDANGERING, SLOWING DOWN, OBSTRUCTING, PREVENTING OR OTHERWISE INTERFERING WITH VEHICULAR ACCESS TO, INTO OR OFF ANY PETROL STATION OR ITS FORECOURT WITHIN THE ADMINISTRATIVE AREA OF THURROCK (AS MARKED ON THE MAP AT ANNEXE 2 TO THE CLAIM FORM)

(226) PERSONS UNKNOWN, WHO ARE FOR THE PURPOSE OF PROTESTING, CAUSING THE BLOCKING, ENDANGERING, SLOWING DOWN, OBSTRUCTING, PREVENTING OR OTHERWISE INTERFERING WITH

VEHICULAR ACCESS TO OR FROM ANY PETROL STATION OR ITS FORECOURT WITHIN THE ADMINISTRATIVE AREA OF ESSEX (AS MARKED ON THE MAP AT ANNEXE 3 TO THE CLAIM FORM)

(227) PERSONS UNKNOWN, WHO ARE FOR THE PURPOSE OF PROTESTING, BLOCKING, PREVENTING OR OTHERWISE INTERFERING WITH THE OFFLOADING BY DELIVERY TANKERS OF FUEL SUPPLIES AND/OR THE REFUELLING OF VEHICLES AT ANY PETROL STATION WITHIN THE ADMINISTRATIVE AREA OF THURROCK (AS MARKED ON THE MAP AT ANNEXE 2 TO THE CLAIM FORM)

(228) PERSONS UNKNOWN, WHO ARE FOR THE PURPOSE OF PROTESTING, BLOCKING, PREVENTING OR OTHERWISE INTERFERING WITH THE OFFLOADING BY DELIVERY TANKERS OF FUEL SUPPLIES AND/OR THE REFUELLING OF VEHICLES AT ANY PETROL STATION WITHIN THE ADMINISTRATIVE AREA OF ESSEX (AS MARKED ON THE MAP AT ANNEXE 3 TO THE CLAIM FORM)

(229) PERSONS UNKNOWN WHO ARE TRESPASSING ON, UNDER OR ADJACENT TO THE ROADS LISTED AT ANNEXE 1 TO THE CLAIM FORM BY UNDERTAKING EXCAVATIONS, DIGGING, DRILLING AND/OR TUNNELLING WITHOUT THE PERMISSION OF THE RELEVANT HIGHWAY AUTHORITY

Defendants

ANNEXE 3



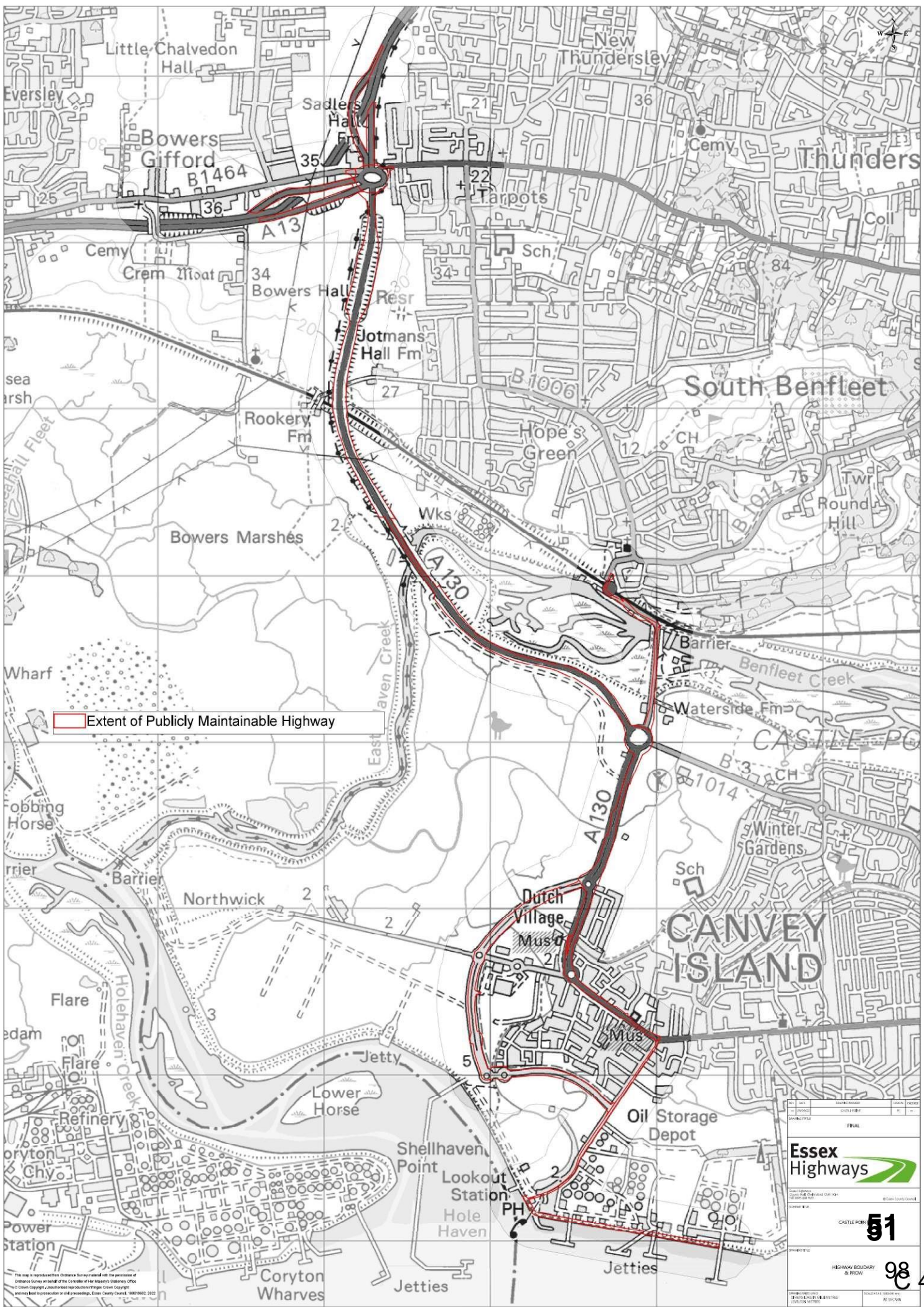

Extent of Publicly Maintainable Highway

DATE	DESCRIPTION	BY	FOR
14/08/2014	FINAL	ESSEX HIGHWAYS	ESSEX HIGHWAYS
Essex Highways			
			
51 <small>CASTLE POINT</small>			
984 <small>HIGHWAY BOUNDARY & FERRY</small>			
<small>ESSEX HIGHWAYS</small>			

This map is reproduced from Ordnance Survey data with the permission of Ordnance Survey on behalf of the Controller of Her Majesty's Stationery Office. © Crown Copyright. All rights reserved. No part of this publication may be reproduced without the prior written permission of Ordnance Survey. Ordnance Survey Licence No. 100019622. 2012



Nine Just Stop Oil supporters found guilty after disrupting the UK's largest oil terminal

Court & Prison, Press / March 8, 2023

Nine Just Stop Oil Supporters have been found guilty after causing disruption to the flow of oil out of the largest fuel terminal in the country in 2022. The Just Stop Oil supporters were demanding that the government halt licensing and consents for the development of any new fossil-fuel projects in the UK. [1]

Tez Burns Rik Vanhoutteghem and one other appeared before Judge Donoghue, at Chelmsford Magistrates Court, on Monday. All three were charged with aggravated trespass at Navigator Fuel Terminal in Grays, Essex, on the 4th April 2022. Tez Burns was sentenced to an 18 month conditional discharge with costs of £215 and Rik Vanhoutteghem was given a 60 hour community order, with costs of £270. Michael Brown pleaded guilty to the charge of Aggravated Trespass, at Navigator, on the 1st April 2022, and was given a 40 hours community order, as well as fees of £160. [2]

Rosa Sharkey, Oliver Stevens and Alexandra Mulvey appeared before Judge Donoghue on Monday and Tuesday, also charged with aggravated trespass, at Navigator, on the 4th April 2022. In addition, they have been charged with wilful obstruction of the highway, at the same terminal, on the 1st April 2022. Rosa Sharkey, Oliver Stevens and Alexandra Mulvey have each been fined £414 inclusive of court fees and surcharge.

Louis McKechnie, and Matthew Powell appeared on Monday and Tuesday, solely in relation to obstruction of the highway, at Navigator, on the 1st April 2022. Louis McKechnie was fined £354, inclusive of court fees and surcharge. Matthew Powell received a 12 month conditional discharge and was charged £144 in fees. [3]

Speaking after the trial on Tuesday, Oliver Stevens, 20, a biology student from Bristol, said:

"I took action with Just Stop Oil out of desperation to secure a future that is liveable, both for my generation and future generations."

"We are seeing normal members of the public realising that the government will not commit to any meaningful actions to prevent irreversible climate breakdown, and so we are left with little choice but to force the government to act."

A Just Stop Oil spokesperson said:

"History will not look kindly on the judges that have criminalised these good people for taking a stand against an industry that is wreaking havoc on our communities. Oil companies have bought our politicians and engaged in a concerted effort to lie about the impact of burning fossil fuels and mislead the public for decades. As the worst drought in 500 years continues across Europe, crops are failing and currently we are already seeing rationing in supermarkets."

"We say to all those working in the judiciary, who are co-operating with these trials; take a stand, or let history be the judge of you. Those complicit in climate crimes will be held to account one day, it is simply a matter of time."

Since the Just Stop Oil campaign launched on the 14th February 2022, there have been over 2,000 arrests and 138 people have spent time in prison, many without trial. There are currently two Just Stop Oil supporters and two Insulate Britain supporters in prison whilst awaiting trial or serving sentences for actions taken with the campaigns.

We stand with these four supporters in prison, with the 1,800 victims of our broken criminal justice system, imprisoned for over a year without trial and with the 1,700 murdered across the global south, for protecting all our lives. [4] [5]

This is the moment for us to come together and resist the destruction of everything we love, something that is being imposed on us by a few, who only seek to enrich themselves.

We're done with begging. We are going to stop new fossil fuel projects whether those in power agree or not. As citizens, parents and children, we have every right under British law to protect ourselves and those we love.

We are the last generation who can solve this. Will you step up? Join us and Just Stop Oil.

ENDS

Press contact: 07762 987334

Press email: juststopoilpress@protonmail.com

High quality images & video here: <https://juststopoil.org/press-media>

Website: <https://juststopoil.org/>

Facebook: <https://www.facebook.com/JustStopOil/>

Instagram: <https://www.instagram.com/just.stopoil/>

Twitter: https://twitter.com/JustStop_Oil

Notes to Editors

[1] Just Stop Oil is a coalition of groups working together to demand that the government immediately halt all future licensing and consents for the exploration, development and production of fossil fuels in the UK. Just Stop Oil is a member of the A22 Network of civil resistance projects. Climate Emergency Fund is Just Stop Oil's primary funder for recruitment, training, and capacity building.

[2] Link to press release from 4th April 2022- <https://juststopoil.org/2022/04/04/petrol-shortage-as-just-stop-oil-disrupt-supply-from-uk-oil-terminals/>

[3] Link to press release from 1st April 2022- <https://juststopoil.org/2022/04/01/breaking-just-stop-oil-coalition-blocks-7-critical-oil-facilities-to-demand-an-end-to-new-oil-and-gas/>

[4] Fair Trials reports that the number of people being held in prison without trial in England and Wales is at its highest for over 50 years.

[5] A recent report from Global Witness says that more than 1,700 people have died while trying to prevent mining, oil drilling or logging on their lands.

[← Previous Post](#)

[Next Post →](#)

Related Posts



Breaking: 'Just Stop Oil' youth campaigners deliver ultimatum to Boris Johnson

Press / February 14, 2022



Two Students Spray Paint Three London Universities As Part of 'Just Stop Oil' Campaign

Press / March 2, 2022

Just Stop



Breaking: Just Stop Oil responds to Prime Minister's call for a "climate change pass"

Press / March 10, 2022

Support
Just Stop Oil

[Donate](#)

Join Our Mailing List

EMAIL SUBSCRIPTION FORM

- I'm happy to get occasional texts and calls about specific actions or about events I've signed up to.

[Not in GB?](#)

SUBMIT

- Opt in to email updates from Just Stop Oil



Follow us on social media.

About us

Just Stop Oil is a nonviolent civil resistance group demanding the UK Government stop licensing all new oil, gas and coal projects. [FAQs](#) | [The Campaign](#) | [Research](#)

Contact us

Press enquiries: juststopoilpress@protonmail.com

General enquiries: info@juststopoil.org

Donation enquiries:

juststopoilgiving@protonmail.com

Volunteer enquiries: jsovolunteers@gmail.com

Book a speaker: contact@juststopoil.org

Stay in touch

SIGN UP FOR OUR NEWSLETTER

ADD YOUR NAME

Opt in to email updates from Just Stop Oil

REGION (TO ADD YOU TO THE CORRECT REGIONAL MAILING LIST) *

ARE YOU A STUDENT?
(IF YES, WE CAN ADD YOU TO OUR STUDENTS SPECIFIC EMAILING LIST)

Yes

[Not in GB?](#)

Sponsored by: Just Stop Oil



Close



Report

Tell us about

Apply or register

Request

Thanks and complaints

Your area

Twelve people charged following break ins

News

🕒 Published: 11:08 21/06/2022

Twelve people have been charged following two break ins at MBR Acres.

Police initially attended the site in Sawtry Way, Wyton, at 5am on Sunday morning (19 June) following reports of a burglary.

Officers attended again at about 3am yesterday morning (20 June) following further reports of a break in and dogs being taken.

Twelve people have since been charged with burglary and are due to appear at Cambridge Magistrates' Court today (21 June).

The dogs have yet to be recovered.

Details of those charged below:

- Sara Harrison, 52, of Hallowes Court, Dronfield, Derbyshire.
- Kat Chan, 20, of Hamiltonhill Gardens, Glasgow.
- Safron Macdonald, 23, of Marlborough Grove, Prenton, Merseyside.
- Francesca Vaz, 27, of The Avenue, London.
- Rosa Sharkey, 22, of Dewe Road, Brighton.
- Sofia Fernandes Pontes, 25, of Copenhagen Street, Kings Cross, London.
- Rachel Steele, 46, of Capworth Street, London.
- Robert Gordon, 26, of Walker Drive, York.
- Callum Goode, 22, of Compton, Ashbourne, Derbyshire.
- Ben Newman, 31, of Wintergreen Court, Homerton, London.
- Daniel Kidby, 30, of West Stockwell Street, Colchester, Essex.
- Robert Houston, 43, of Byng Road, Barnet, London.

Share



[Is there a problem with this page?](#)

Cambridgeshire Constabulary

Contact us
Find a police station
News
Jobs and volunteering
About us
Campaigns
Terms and conditions
Accessibility
Privacy notice
Cookies

Information and services

Advice and information
Crime prevention advice
Accessing information
Stats and data
Report
Tell us about
Apply or register
Request
Feedback

Partners

Partner services
Police & Crime Commissioner
Police.uk
Ask the Police

Follow us on:



NEWS

Home | Israel-Gaza war | Cost of Living | War in Ukraine | Climate | UK | World | Business | Politics | Culture

More

England | Local News | Regions | Norfolk

Sandringham Estate: Three charged after lambs stolen

21 August 2023



PA MEDIA

Three lambs were taken from a field on the Sandringham Estate in Norfolk in May

Three women have been charged after lambs were stolen from a field on the King's Sandringham Estate.

Protest group Animal Rising previously claimed to be behind the theft at West Newton, Norfolk, in May.

Norfolk Police said Sarah Foy, 23, Rose Patterson, 34, and Rosa Sharkey, 23, had been charged with theft and animal welfare offences.

They were released on police bail and are due to attend King's Lynn Magistrates' Court on 28 September.

Ms Foy, of North Street, Alfreton, Derbyshire; Ms Patterson, of Homerton High Street, London; and Ms Sharkey, of Mayville Estate, London, have each been charged with:

- One count of stealing three lambs from a farm in West Newton between 24 and 25 May
- Three counts of causing unnecessary suffering to a protected animal between 24 and 25 May
- Three counts of failing to record movement of an animal on 24 May.

Find BBC News: East of England on [Facebook](#), [Instagram](#) and [Twitter](#). If you have a story suggestion email eastofenglandnews@bbc.co.uk or get in touch via WhatsApp on 0800 169 1830

Related Topics

[UK Royal Family](#)

[Alfreton](#)

[London](#)

[Sandringham](#)

Related Internet Links

[HM Courts Service](#)

The BBC is not responsible for the content of external sites.

From other local news sites

[Hundreds prosecuted for TV licence evasion in single year](#)

Wymondham & Attleborough Mercury

[Urgent weather warning issued by Met Office with gusts of up to 50mph](#)

Wymondham & Attleborough Mercury

[Last week's death notices: Couple who died within days of each other and sugar worker](#)

EDP 24

[Norfolk police has second fastest average response time to 999 calls](#)

Norwich's open-top sightseeing bus to stop after founder's death

EDP 24

Listed guesthouse with sea views of the Norfolk coast up for auction

North Norfolk News

i [Information about BBC links to other news sites](#)

Top Stories

LIVE Middle East 'on the brink' after Iran's attack on Israel, warns UN chief

Bowen: As Israel debates Iran attack response, can US and allies stop slide into all-out war?

'Obvious' Sydney killer targeted women, police say

13 hours ago

1 hour ago

Features

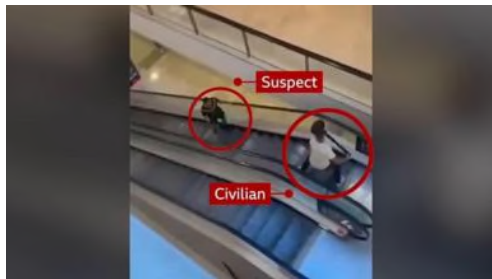

'Hero' who took on killer describes Sydney attack



BBC Verify examines video from Iran's attack on Israel



What was in wave of Iranian attacks and how were they thwarted?



Listen: Is this a turning point for Iran and Israel?

Sounds



Primary school places 2024: When do parents find out offers?



Watch: Rushdie reveals extent of his wounds from knife attack



Watching my country fall apart day-by-day

The Papers: Israel 'vows revenge' as it 'weighs up response'

The sharp-tongued president livening up Croatia's election

Elsewhere on the BBC



Charlotte Church explores her working class childhood

Expect mindful moments, laughter and a few tales of teens sneaking into clubs...

Sounds



Could switching to olive oil be good for your health?

Michael Mosley discovers the surprising benefits of this component of the Mediterranean diet

Sounds



Maggie Rogers performs in Radio 1's Live Lounge

Enjoy her song 'Don't Forget Me' and an incredible cover of Tate McRae's 'Greedy'

iPlayer



This is the poetry show without the poetry!

Tim Key's smart, comedic chaos with guests Stephen Merchant and Lolly Adefope

Sounds

Most Read

1 'Obvious' Sydney killer targeted women - police

2 Israel 'vows revenge' as it 'weighs up response'

3 Salman Rushdie: Losing an eye upsets me every day

4 Universal Credit 'must change' to tackle sickness

5 Sunset Boulevard equals Olivier Awards record

6 Oil prices dip after Iran attack on Israel 109

7 Boycott of Downing Street Eid celebration planned

8 Judge finds Australia parliament rape reports were true

9 Why has Iran attacked Israel?

10 Trump's first criminal trial to begin in New York

BBC News Services

 On your mobile

 On smart speakers

 Get news alerts

 Contact BBC News

Best of the BBC



Which pair will conquer the world first?

 BBC iPlayer



Annie and Nick bring us the latest scoop

 BBC Sounds



Who glows and who goes?

 BBC iPlayer



Marriage, divorce, and perfect pop

 BBC Sounds

[Home](#)

[Weather](#)

[CBBC](#)

[Bitesize](#)

[Local](#)

[News](#)

[iPlayer](#)

[CBeebies](#)

[Arts](#)

[Three](#)

[Sport](#)

[Sounds](#)

[Food](#)

[Taster](#)

[Terms of Use](#)

[About the BBC](#)

[Privacy Policy](#)

[Cookies](#)

[Accessibility Help](#)

[Parental Guidance](#)

[Contact the BBC](#)

[Make an editorial complaint](#)

[Get Personalised Newsletters](#)

[Why you can trust the BBC](#)

© 2024 BBC. The BBC is not responsible for the content of external sites. [Read about our approach to external linking.](#)



- Today, Animal Rising has released a photo of the three lambs rescued from the Sandringham Estate last May. The photo shows the lambs fully grown, happy, and healthy.
- On 24/5/23, three women (Rose, Sarah, and Rosa) rescued three lambs from King Charles III's Appleton Farm to save them from being killed for meat and begin "a national conversation about our broken relationship with other animals and the natural world" [1].
- Despite saving the lives of the three animals, the three women are set to stand trial at Norwich Crown Court later this year [2].

An updated photo of the animals has been released almost a year after the rescue of three lambs belonging to King Charles III. The photo shows the animals fully grown and happy, a sharp contrast to the fate they would have experienced if left unsaved.

Sarah Foy, one of the women who rescued the animals said:

"It's heartwarming to see Sammy, Sunny, and Sooty grown up and enjoying life; they'll now have the opportunity to reach their full lifespan of a decade or more. It's incredible to hear about the bond the three have formed with each other. In a nation of animal lovers, this is how sheep, cows, chickens, and all animals should be able to live."

The release of this photo comes shortly after Animal Rising released a photo of one of the beagles the group rescued from MBR Acres in 2022 [3]. Since Summer 2022, the group has rescued a total of 28 animals on three separate occasions - putting the spotlight on industries such as animal testing and farming.

The action also aimed to highlight the environmental damage caused by animal farming and fishing, with around 16% of UK land is dedicated purely to sheep grazing, whilst providing less than 1% of dietary calories [4].

In 2018, comprehensive research from the University of Oxford showed that 76% of the land currently used for food production would be freed-up by a global transition to plant-based production [5]. This land could be rewilded and begin carbon drawdown, mitigating the worst impacts of climate breakdown.

Dan Kidby, Co-Founder of Animal Rising said:

"I believe that we truly are a nation of animal lovers. Many of us wouldn't hesitate to help a dog trapped in a hot car, and the rescue of Sammy, Sunny, and Sooty is no different. We all have the urge to step up and defend innocent life, and now is the time to bring that compassion to the surface and create a better world for all life."

Animal Rising is a social movement to create a new relationship with all beings and give us a chance for a safe ecological future. The group primarily calls for the transition to a secure and sustainable plant-based food system, alongside a mass rewilding programme.

ENDS

Word Count: 482

High-Quality Pictures and Videos: <https://show.pics.io/animal-rising-breaking-news>

All images and videos in this file, on our social media, and website can be used with credit to Animal Rising under 'fair use' for the purposes of reporting.

For more information or further comments, please contact:

Nathan (Press Back Office) +44 1225 29 6691

press@animalrising.org

Notes To The Editor:

[1] <https://www.animalrising.org/post/royal-sheep-rescue-animal-rising-free-animals-from-sandringham-estate>

[2] https://www.edp24.co.uk/news/23819082_women-deny-stealing-kings-lambs-field-sandringham/

[3] <https://www.animalrising.org/post/rescued-beagles-from-animal-testing-photo-released-of-max-now>

[4] <https://www.thealternative.org.uk/dailyalternative/2022/1/31/animal-agriculture-crowding-out-solar>

[5] <https://www.science.org/doi/10.1126/science.aag0216>

Sandringham Sheep Rescue: Further Footage Released



- Animal Rising has released further footage of the "open rescue" of 3 sheep from the royal estate at Sandringham yesterday evening [1] [2].
- The group can confirm the animals have not been returned to the farmer or released into the wild, they are safe and with animal experts who will care for them and allow them to live happily.
- The rescuers, Rosa Sharkey, Sarah Foy, and Rose Patterson are now in police custody at Maidenhead.

Rosa Sharkey, 23, said:

"Our actions yesterday have saved a family of sheep from slaughter; but they've also asked a broader question about our broken relationship with animals and nature. We've rescued sheep from Sandringham because the Royal Family, more than any other, have a responsibility to lead by example and show the way towards tackling the climate and nature crises. The sheep here are living beings, worthy of freedom just like any one of us.

King Charles is a self-proclaimed environmentalist and nature lover, it is up to him to put right on that. He and his family are the global representatives of a nation known for being animal lovers - they ought to show it."

ENDS.

Word Count: 200

High-Quality Pictures and Videos: <https://show.pics.io/animal-rebellion-breaking-news>

All images and videos in this file, on our social media, and website can be used with credit to Animal Rising under 'fair use' for the purposes of reporting.

For more information or further comments, please contact:

Nathan (Press Back Office) +44 1225 29 6691

press@animalrising.org

Notes To The Editor:

[1] <https://www.animalrising.org/post/royal-sheep-rescue-animal-rising-free-animals-from-sandringham-estate>

[2] Open Rescue is a means of rescuing animals from suffering and captivity inside laboratories, breeding facilities and industrial farms that does not hide the identity of the rescuing humans, who will hand themselves in to the police once the animals have been taken to safety. It was introduced as a tactic by Animals Victoria in Australia to show nonviolence and transparent tactics by those taking action for animals.

f X in e

354 views



Recent Posts

See All

Aintree Coverup Grand National Fall

33



Grand National 2024: Animal Rising Comment

Corach Rambler, last year's winner, fell early - unseating their rider and eventually gaining their footing. Alongside this, multiple...

22



Jockey Club Communication Ahead Of Grand

Ahead of 2024's Grand National, Animal Rising has communicated its decision not to disrupt the race to Nevin Truesdale personally...

73

